

7600 Precision LCR Meter
Model B
Instruction Manual
Form 150261/A6

©QuadTech, Inc., 1997, 2007

QuadTech LCR Meters are now sold and supported by
IET Labs www.ietlabs.com

The material in this manual is for informational purposes only and is subject to change, without notice. QuadTech assumes no responsibility for any error or for consequential damages that may result from the misinterpretation of any procedures in this publication.

Contents

| | |
|--|------|
| Warranty | vii |
| Specifications | ix |
| Introduction - Section 1 | |
| 1.1 Unpacking and Inspection | 1-1 |
| 1.2 Product Overview | 1-1 |
| 1.3 Controls and Indicators | 1-2 |
| 1.4 Accessories Included | 1-5 |
| 1.5 Accessories/Options Available | 1-5 |
| 1.6 Installation | 1-6 |
| 1.6.1 Instrument Positioning | 1-6 |
| 1.6.2 Power Requirements | 1-6 |
| 1.6.3 Safety Inspection | 1-7 |
| Operation - Section 2 | |
| 2.1 General | 2-1 |
| 2.2 Startup | 2-1 |
| 2.3 Connection to Device Under Test | 2-1 |
| 2.4 Zeroing | 2-2 |
| 2.5 Measurement Procedure | 2-3 |
| 2.5.1 General | 2-3 |
| 2.5.2 Default Measurement Conditions | 2-3 |
| 2.6 Menu Functions | 2-5 |
| 2.6.1 General | 2-5 |
| 2.6.2 Setup Menu | 2-5 |
| 2.6.2.1 Primary Parameter | 2-6 |
| 2.6.2.2 Secondary Parameter | 2-9 |
| 2.6.2.3 Frequency | 2-10 |
| 2.6.2.4 AC Test Signal | 2-10 |
| 2.6.2.5 DC Bias Voltage | 2-11 |
| 2.6.2.6 Range Hold | 2-14 |
| 2.6.2.7 Range Locked | 2-15 |
| 2.6.2.8 Measurement Accuracy | 2-20 |
| 2.6.2.9 Measurement Delay | 2-20 |
| 2.6.2.10 # to Average | 2-21 |
| 2.6.2.11 Contact Check | 2-21 |

Contents (continued)

| | | |
|----------|--|------|
| 2.6.3 | I/O Menu..... | 2-22 |
| 2.6.3.1 | Display Type..... | 2-23 |
| 2.6.3.2 | Nominal Value..... | 2-26 |
| 2.6.3.3 | Result Format..... | 2-26 |
| 2.6.3.4 | Trigger..... | 2-27 |
| 2.6.3.5 | Handler Interface..... | 2-27 |
| 2.6.3.6 | RS-232 Interface..... | 2-27 |
| 2.6.3.7 | IEEE-488.2 Interface..... | 2-28 |
| 2.6.3.8 | Print Results..... | 2-28 |
| 2.6.3.9 | Results to Floppy..... | 2-29 |
| 2.6.4 | Analysis Menu..... | 2-35 |
| 2.6.4.1 | Binning..... | 2-36 |
| 2.6.4.2 | Test Sequencing..... | 2-41 |
| 2.6.4.3 | Parameter Sweep..... | 2-44 |
| 2.6.4.4 | Median..... | 2-46 |
| 2.6.4.5 | Distortion Detection..... | 2-46 |
| 2.6.4.6 | Load Correction..... | 2-46 |
| 2.6.5 | Utilities Menu..... | 2-48 |
| 2.6.5.1 | Save Setup..... | 2-49 |
| 2.6.5.2 | Recall Setup..... | 2-50 |
| 2.6.5.3 | Setup Accuracy..... | 2-51 |
| 2.6.5.4 | Open / Short..... | 2-54 |
| 2.6.5.5 | Lock Out..... | 2-55 |
| 2.6.5.6 | Calibration..... | 2-56 |
| 2.6.5.7 | Set Time/Date..... | 2-56 |
| 2.6.5.8 | Usage/Cal Date..... | 2-57 |
| 2.6.5.9 | Set Contrast..... | 2-57 |
| 2.6.5.10 | Self Test..... | 2-58 |
| 2.6.5.11 | LCD Backlite..... | 2-58 |
| 2.7 | Input/Output Interface..... | 2-59 |
| 2.7.1 | I/O Interface..... | 2-59 |
| 2.7.2 | Parallel Interface..... | 2-63 |
| 2.7.3 | IEEE-488.2 Interface..... | 2-64 |
| 2.7.3.1 | Formats..... | 2-74 |
| 2.7.3.2 | Sample Program for National Instruments GPIB card..... | 2-76 |
| 2.7.4 | RS232 Interface..... | 2-77 |
| 2.7.5 | Results to Printer..... | 2-78 |

Contents (continued)

| | | |
|--------|--|------|
| 2.8 | Operation with Accessories | 2-79 |
| 2.8.1 | General..... | 2-79 |
| 2.8.2 | Rack Mount Kit (7000-00) | 2-79 |
| 2.8.3 | BNC Cable Set, 1 Meter (7000-01), 2 Meter (7000-02)..... | 2-79 |
| 2.8.4 | Kelvin Clip Leads (7000-03) | 2-80 |
| 2.8.5 | Alligator Clip Leads (7000-04)..... | 2-82 |
| 2.8.6 | Chip Component Tweezers (7000-05)..... | 2-83 |
| 2.8.7 | Low V, Axial/Radial Lead Component Test Fixture (7000-06)..... | 2-84 |
| 2.8.8 | Low V, Chip component Test Fixture (7000-07) | 2-85 |
| 2.8.9 | High Voltage Test Fixture (7000-08) | 2-87 |
| 2.8.10 | Calibration Kit (7000-09) | 2-88 |
| 2.8.11 | Connections to 874 Type Adapters..... | 2-89 |

| | | |
|-----|----------------------|------|
| 2.9 | Error Messages | 2-90 |
|-----|----------------------|------|

Theory Section 3

| | | |
|-------|---|-----|
| 3.1 | General..... | 3-1 |
| 3.2 | Instrument Description | 3-1 |
| 3.2.1 | Basic I2000 Instrument Architecture | 3-1 |
| 3.2.2 | 7600 Instrument Module..... | 3-2 |
| 3.2.3 | I2000 Instrument Options | 3-3 |

Maintenance/Calibration - Section 4

| | | |
|-------|---------------------------------------|-----|
| 4.1 | General..... | 4-1 |
| 4.2 | Instrument Return | 4-1 |
| 4.3 | Routine Maintenance | 4-1 |
| 4.3.1 | Battery Replacement..... | 4-1 |
| 4.3.2 | Bias Voltage Fuse Replacement | 4-2 |
| 4.3.3 | Resetting of Time and Date | 4-2 |
| 4.3.4 | Loss of Display Contrast..... | 4-3 |
| 4.3.5 | Preventive Maintenance/Cleaning | 4-4 |
| 4.4 | Calibration | 4-4 |
| 4.4.1 | General..... | 4-4 |
| 4.4.2 | Calibration Procedure | 4-4 |

Warranty



QuadTech warrants that Products are free from defects in material and workmanship and, when properly used, will perform in accordance with QuadTech's applicable published specifications. If within one (1) year after original shipment it is found not to meet this standard, it will be repaired, or at the option of QuadTech, replaced at no charge when returned to a QuadTech service facility.

Changes in the Product not approved by QuadTech shall void this warranty.

QuadTech shall not be liable for any indirect, special or consequential damages, even if notice has been given of the possibility of such damages.

This warranty is in lieu of all other warranties, expressed or implied, including, but not limited to any implied warranty or merchantability or fitness for a particular purpose.

SERVICE POLICY

QuadTech policy is to maintain product repair capability for a period of at least five (5) years after original shipment and to make this capability available at the then prevailing schedule of charges.

Specifications

Measurement Parameters: Capacitance (Cs/Cp), Inductance (Ls/Lp), Resistance (Rs/Rp), Dissipation (DF) and Quality (Q) Factors, Impedance (|Z|), Admittance |Y|, Phase Angle (θ), Equivalent Series Resistance (ESR), Conductance (Gp), Reactance (Xs), Susceptance (Bp)
Any two parameters measured and displayed simultaneously
Note: s = series, p = parallel, ESR equivalent to Rs

Measurement Ranges:
 |Z|, R, X: 000.0001 mohm to 99.99999 Mohm
 |Y|, G, B: 00000.01 μ S to 9.999999 MS
 C: 00000.01 fF to 9.999999 F
 L: 0000.001 nH to 99.99999 H
 D: .0000001 to 99.99999
 Q: .0000000 to 999999.9
 Phase Angle: -180.0000 to +179.9999 degrees
 Delta %: -99.9999 % to +99.9999 %

Measurement Accuracy:

| | <u>Fast</u> | <u>Medium</u> | <u>Slow</u> |
|------|-------------|---------------|-------------|
| LCR: | +/- 0.5%* | +/- 0.25%* | +/- 0.05%* |
| DF: | +/- 0.005 | +/- 0.0025 | +/- 0.0005 |

* At optimum test signal levels, optimum DUT value and without calibration uncertainty error. Instrument accuracy can be reduced from nominal specifications when using some 7000 accessory fixtures and cables. Best accuracy requires geometric consistency between that utilized during open/short zeroing and that utilized on fixtures and cables during the actual measurement process. This consistency may be especially difficult to achieve when using unshielded Kelvin clip and tweezer type connections.

0.25 x (normal accuracy) with Load Correction implemented and compared to user supplied standard.

In a range of $3\Omega \leq Z \leq 80k\Omega$, $100mV \leq \text{programmed } V \leq 1V$ or $100mV \leq (\text{programmed } I) \times (Z) \leq 1V$

Test Frequency: 10 Hz to 2 MHz
 Resolution: 0.1 Hz from 10 Hz to 10 kHz
 5 digits > 10 kHz, 4 digits > 100 kHz
 Accuracy: +/- (0.25% + 0.02 Hz)

Measurement Speed: Fast Accuracy: 40 msec*/measurement
 Medium Accuracy: 125 msec*/measurement
 Slow Accuracy: 1 sec*/measurement
 * may be longer, depending on test conditions & frequency

Ranging: Automatic or Range Hold

Specifications (continued)

| | |
|-----------------------------|--|
| Source Impedance: | 25 Ω , 400 Ω , 6.4 k Ω or 100 k Ω , measurement range dependent |
| Trigger: | Internal (automatic) and External (via handler, RS-232 or IEEE-488.2 interfaces) |
| AC Test Signal Voltage: | 20 mV to 5.0 V (open circuit) in 5 mV steps, $\leq 500\text{kHz}$ 20 mV to 1.0 V (open circuit) in 5 mV steps, $>500\text{kHz}$ to $\leq 1\text{MHz}$ 20 mV to 0.5 V (open circuit) in 5 mV steps, $>1\text{MHz}$ Accuracy: +/- (5% + 1 mV) $< 100\text{kHz}$ +/- (10% + 1 mV) 100kHz to 500kHz +/- (20% + 1 mV) 500kHz to 1MHz +/- (35% + 1 mV) $> 1\text{MHz}$ |
| AC Test Signal Current: | 250 μA to 100 mA (short circuit) in 50 μA steps Max Compliance: 3V $< 500\text{kHz}$, 1V from 500kHz - 1MHz 0.5V $> 1\text{MHz}$ Accuracy: +/- (5% +50 μA) $< 100\text{kHz}$ +/- (10% +50 μA) 100kHz to 500kHz +/- (20% +50 μA) 500kHz to 1MHz +/- (35% +50 μA) $> 1\text{MHz}$ |
| Bias Voltage: | Internal: 2.0 V External: 0 to +/-200 V |
| Display: | LCD Graphics with adjustable contrast and back light - Results of Dual Measurement Parameters in engineering (7 digits) or scientific (5 digits) notation - Deviation from Nominal of Primary Parameter - % Deviation from Nominal of Primary Parameter - Instrument Setting and Test Conditions - Bin Limits and Pass/Fail Results - Plot of Primary Measurement Parameter vs. Test Conditions - Table of Measurement Parameters vs. Test Conditions - Sequenced Test Results Summary |
| Limit Detection: | 15 bins total (10 pass, 4 fail, 1 no contact) |
| Interfaces: | IEEE-488.2, RS-232, Handler, Printer Port and 3.5" Floppy Dr. |
| Front Panel Test Terminals: | Four terminal (BNC) with Guard |
| Environmental: | MIL-T-28800E, Type 3, Class 5, Style E & F. Operating: 0 to + 50 $^{\circ}$ C. Storage: - 40 to + 71 $^{\circ}$ C. Humidity: < 75% for < 40 $^{\circ}$ C operating Altitude <2000m, Installation Category 1, Pollution Degree 1 |

Specifications (continued)

Mechanical: Bench mount with tilt bail
 Dimensions: (w x h x d):410 x 150 x 360mm
 Weight: 8kg net, 10.5kg shipping

Power Requirements: 90 to 250Vac 47 - 63 Hz 40W maximum

Other Features: Charged Capacitor Protection: $\sqrt{8/C}$ for $V_{max} \leq 250 V$
 $\sqrt{2/C}$ for $V_{max} \leq 1000V$
 C = Capacitance in farads of the device under test
 Measurement Delay programmable from 0-1000 ms in 1 ms steps
 Measurement Averaging programmable from 1-1000
 Median value Mode
 Open and Short Circuit Zeroing at Multiple Frequencies
 Power Fail Protection (setting, results, & calibration data stored)
 Storage and Recall of 25 Setups, 125/disk w/Floppy Option
 Self-Test Routines at Power-up
 Stored Results up to 40,000 measurements/disk w/Floppy Option
 Self Accuracy Calibration and Display
 Contact Check

Supplied: Instruction Manual Power Cable Calibration Certificate

| Ordering Information: | <u>Description</u> | <u>Catalog No.</u> |
|--------------------------|--|--------------------|
| | 7600 Precision LCR Meter, Model B | 7600 |
| | 7600-CE Precision LCR Meter, Model B | 7600-CE |
| | 7600A Precision LCR Meter, Model B, +/-500V ext bias | 7600A |
| | 7600A-CE Precision LCR Meter, Model B +/-500V ext bias | 7600A-CE |
| | Options & Accessories: | |
| | Rack Mount Kit | 7000-00 |
| | BNC Cable Set, 1 meter | 7000-01 |
| | BNC Cable Set, 2 meters | 7000-02 |
| | Kelvin Clip Leads | 7000-03 |
| | Alligator Clip Leads | 7000-04 |
| | Chip Component Tweezers | 7000-05 |
| | Low Voltage Axial/Radial Lead Component Test Fixture | 7000-06 |
| | Low Voltage Chip Component Test Fixture | 7000-07 |
| | High Voltage Test Fixture | 7000-08 |
| | Calibration Kit | 7000- |

1.1 Unpacking and Inspection

Inspect the shipping carton before opening, if damaged contact the carriers agent immediately. Inspect the instrument for any damage. If the instrument appears damaged or fails to meet specifications notify QuadTech (refer to instruction manual front cover) or its local representative. Retain the shipping carton and packing material for future use such as returning for re calibration or service.

1.2 Product Overview

The 7600 Precision LCR Meter is an automatic, user programmable instrument for measuring a wide variety of impedance parameters. The 7600 covers a frequency range from 10 Hz to 2 MHz with a basic measurement accuracy of 0.05%. The instruments high resolution graphics display and keypad makes for easy menu programming. Test conditions are stored and recalled from internal memory, eliminating wasted measurement setup time. Extensive pass/fail binning capability and measurements speeds up to 25/sec makes the unit well suited for production applications.

The instruments unique measurement sequencing allows up to six parameters to be measured on a single pass. Additionally, a parameter can be plotted against a test condition variable, an invaluable technique for component design and product evaluation.

The 7600 comes with IEEE-488.2, RS-232, I/O port (handler), and parallel interfaces, all standard, for remote control operation and communication with other instrumentation. A 3 1/2" floppy drive is also included for program/data storage of test conditions and measurement results.

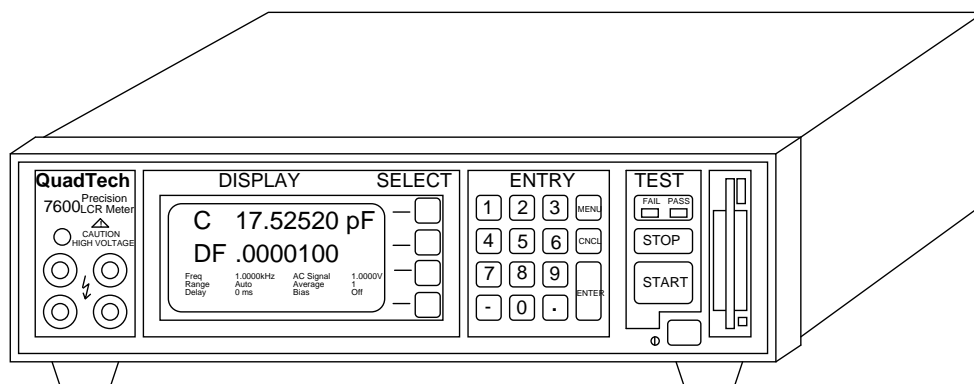

Figure 1-1
7600 Precision LCR Meter

1.3 Controls and Indicators

Figure 1-2 shows the controls and indicators on the front panel of the 7600. Table 1-1 identifies them with descriptions and functions.

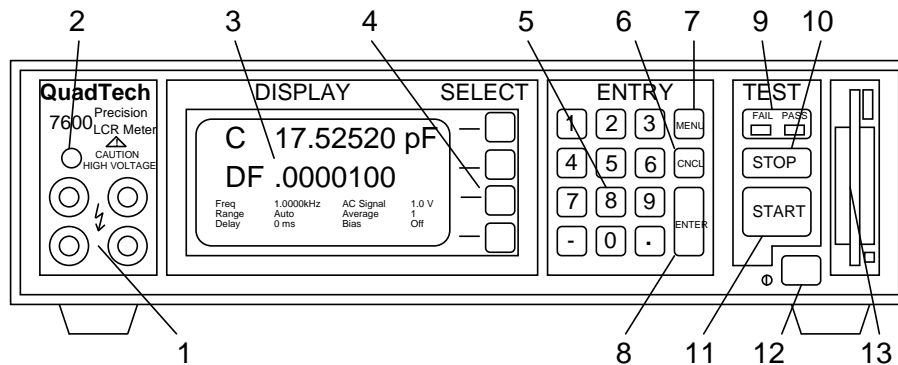

Figure 1-2
Front Panel Controls & Indicators

Table 1-1
Front Panel Controls and Indicators

Figure 1-2

| Ref. No. | Item | Function |
|----------|--------------------------|--|
| 1 | Input Panel | BNC connectors, for connection to device under test (DUT). 7/8 inch spacing. |
| | IL | Current, low connection to DUT |
| | PL | Potential, low connection to DUT |
| | PH | Potential, high connection to DUT |
| | IH | Current, high connection to DUT |
| 2 | Voltage indicator | Indicates when dc bias voltage is called for or applied to rear panel connectors, from external source |
| 3 | Graphics display | Displays test conditions, measured results, instrument status and user interface menus. |

Table 1-1 (continued)
Front Panel Controls and Indicators

Figure 1-2

| Ref. No. | Item | Function |
|-----------------|----------------------------|---|
| 4 | Select keys (4) | Soft key functions as indicated on the adjacent LCD display. - from top to bottom, functions such as up, down, right or left arrow during menu selection. - other functions such as measurement units, exponent, Y or N (yes or no) and del (delete). |
| 5 | Keypad (12) | For making numerical entries as labeled, 0 through 9, minus sign and decimal. |
| 6 | CNCL key | Exits an active field in vertical or horizontal selections, clears entry on # fields when pressed once and exits # fields when pressed twice. |
| 7 | MENU key | Enters menu display mode or exits sub menu back to main menu. |
| 8 | ENTER key | Switches user to entry mode or accepts menu entry as entered. |
| 9 | Pass/Fail indicator | Indicates measurement results based on entered test limits. |
| 10 | STOP key | Stops the measurement process. |
| 11 | START key | Starts the measurement process. |
| 12 | Power switch | Turns main power to instrument on or off. |
| 13 | Floppy drive | For storing measurement setup conditions and measurement results. A high density (1.44M) or low density (720K) DOS compatible floppy drive. Floppies should be double sided, formatted for DOS compatibility. |

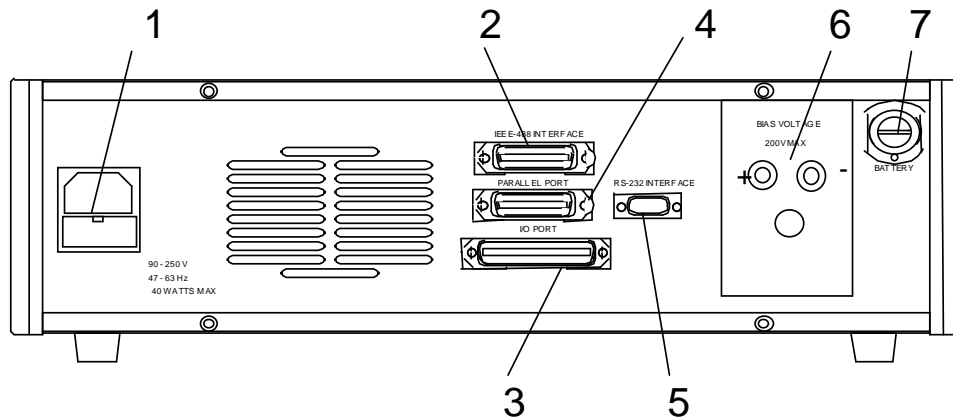

**Figure 1-3
Rear Panel View**

**Table 1-2
Rear Panel Connectors and Controls**

Figure 1-3



| Ref. No. | Item | Function |
|--|------------------------|--|
| 1  | AC Inlet Module | AC power input, filtering, fusing and switching. Use with Belden SPH-socket or equivalent. Contains 250V, 5x20mm time delay fuse for 115 or 220V operation. Replace only with the same type and rating. Also refer to paragraph 1.6.2. |
| 2 | IEEE-488.2 | Input/output connections according to IEEE STD-488.2. 24 pin socket for standard IEEE-488 cable. Refer to paragraph 2.7.3. |
| 3 | I/O Connector | Connection to component handler. 36 pin Amp connector, mates with Amp 552302-1 plug and 552073-5 strain relief cover or ribbon cable clamp connector 553600-1 or equivalents. Refer to paragraph 2.7.1. |
| 4 | Parallel Port | Connection to parallel printer. Type DB25 (25 pin) female connector. Refer to paragraph 2.7.2. |
| 5 | RS232 Connector | Connection according to RS232 std interface. Type DB9 (9 pin) male connector. Refer to paragraph 2.7.4. |

Table 1-2 (continued)
Rear Panel Connectors and Controls

Figure 1-3

| Ref. No. | Item | Function |
|-----------------|---|---|
| 6 |  Bias Voltage | External bias input, maximum of +/-200Vdc. Contains F0.25A, 250V, 5x20mm fast blow fuse. Replace only with the same type and rating. Also refer to paragraph 2.6.2.5. |
| 7 | Battery | DC source for backup of system memory, 3 standard alkaline AA batteries which should be replaced annually (Refer to paragraph 4.3.1) |

1.4 Accessories Included

Table 1-3

| Item | Quantity |
|--|-----------------|
| Instruction Manual | 1 |
| Calibration Certificate | 1 |
| Power Cord (CE units with international cord set) | 1 |
| Fuse (T2.5A, 250V, 5x20mm, for 115/220V operation) | 1 |

1.5 Accessories/Options Available

Table 1-4

| Item | Part Number |
|--|--------------------|
| Rack Mount Kit | 7000-00 |
| BNC Cable Set, 1 meter | 7000-01 |
| BNC Cable Set, 2 meters | 7000-02 |
| Kelvin Clip Leads | 7000-03 |
| Alligator Clip Leads | 7000-04 |
| Clip Component Tweezers | 7000-05 |
| Low Voltage Axial/Radial Lead Component Test Fixture | 7000-06 |
| Low Voltage Chip Component Test Fixture | 7000-07 |
| High Voltage Test Fixture | 7000-08 |
| Calibration Kit | 7000-09 |

1.6 Installation

1.6.1 Instrument Positioning

The 7600 contains a high resolution back lit LCD for convenient viewing. The optimum angle for viewing is straight onto the display. This means that for bench operation the front bail should sometimes be used to angle the instrument up and for rack installation it should be mounted somewhat at eye level.

1.6.2 Power Requirements

 The 7600 Precision LCR Meter can be operated from a power source between 90 and 250Vac at a power line frequency of 47 to 63Hz, no line voltage switching is necessary. Power connection to the rear panel is through an ac inlet module comprised of an ac connector and fuse drawer. Before connecting the 3-wire power cord between the unit and AC power the fuse should be in accordance with the power source, T2.5A, 250V, 5x20mm (QuadTech PN 520049) for 115 or 220V source. Always use an outlet that has a properly connected protection ground. **The 7600 is factory shipped with the 2.5A fuse in place. The instrument can be damaged if the wrong fuse is installed.** To change the fuse proceed as follows:

WARNING

MAKE SURE THE UNIT HAS BEEN DISCONNECTED FROM ITS AC POWER SOURCE FOR AT LEAST FIVE MINUTES BEFORE PROCEEDING.

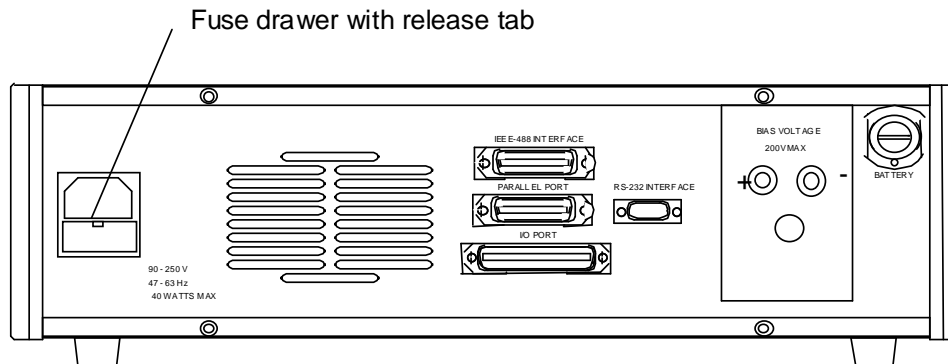

**Figure 1-4
Fuse Drawer**

- Remove the **fuse drawer** by inserting a small flat head screwdriver behind the small tab to force the draw outward. Refer to Figure 1-4.
- Once the fuse drawer has been completely removed from the instrument remove the **clear fuse tray** from the drawer by lifting upward slightly on the long narrow black locking tab. This will allow the fuse tray to be removed from the fuse drawer. This tray contains the active fuse, left side (secured by holder) and spare fuse on the right side (if present). Refer to Figure 1-5.
- Remove the active fuse from the holder by prying upward using a small flat head screwdriver. Insert the replacement fuse into the fuse holder.
- Once the fuse has been installed in the holder and spare fuse (if desired) installed in the right side of the tray insert the tray back into the fuse drawer, push in and lock. The two silver contacts on the fuse tray should be positioned towards the outside.
- Once the fuse tray has been installed in the draw, reinstall the fuse drawer back into the instrument ac inlet module, push in and lock.

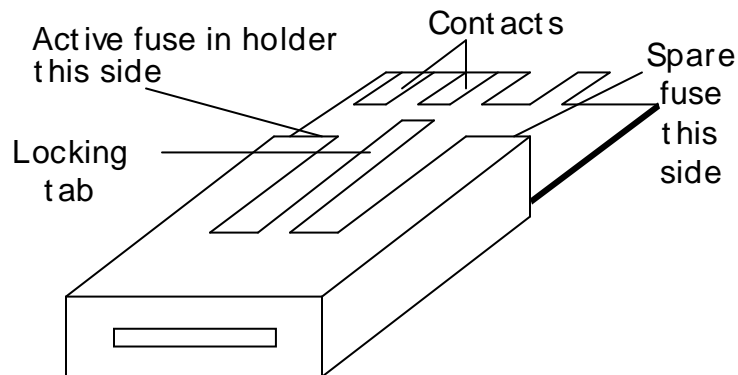

**Figure 1-5
Fuse Drawer**

1.6.3 Safety Inspection



Before operating the instrument inspect the power inlet module on the rear of the 7600 to ensure that the **properly rated fuse is in place**, otherwise damage to unit is possible. Refer to paragraph 1.6.2.

The 7600 is shipped with a standard U.S. power cord, QuadTech PN 4200-0300 (with Belden SPH-386 socket or equivalent, and 3 wire plug conforming to IEC 320) and CE units with an approved international cord set. Make sure the instrument is only used with these cables (or other approved international cord set) that ensures the instrument is provided with **connection to protective earth ground**.

When the 7600 is used in a rack installation (using the QuadTech 7000-00 Rack Mount Kit) make sure the unit is **secured using the cabinet mounting rails** and not secured solely by the front panel angle brackets.

In bench or rack mount applications the instrument should be positioned with consideration for **ample airflow** to the rear panel fan ventilation holes. An open space of at least 3 inches (75mm) is recommended behind the rear panel. The surrounding environment should be **free from excessive dust** to prevent contamination of electronic circuits.

WARNING

If this instrument is used in a manner not specified in this manual protection to the operator and equipment may be impaired.

1. Never touch the metal of the High Voltage probe directly. Touch only the insulated parts of the lead(s).
2. Never touch the test leads, test fixture or DUT in any manner (this includes insulation on all wires and clips) when the high voltage is applied and the red **DANGER** light is ON.
3. Before turning on the Guardian unit, make sure there is no device (DUT) or fixture connected to the test leads.
4. After each test, press the **[STOP]** (red) button for safety. This terminates the high voltage being applied to the output terminals.
5. When the red **DANGER** LED is lit or flashing, NEVER touch the device under test, the lead wires or the output terminals.
6. Before touching the test lead wires or output terminals make sure :
 - a) The red **[STOP]** button has been pressed
 - b) The red **DANGER** LED is OFF.
7. In the case of an emergency, turn OFF the POWER switch using a “hot stick” and disconnect the AC power cord from the wall. **DO NOT TOUCH THE INSTRUMENT.**
8. Position the equipment so it is easy to disconnect. Disconnect by means of the power plug or power connector.
9. If the **DANGER** LED does not go off when the **[STOP]** button is pressed, immediately stop using the tester. It is possible that the output voltage is still being delivered regardless of the TEST ON/OFF control signal.
10. When the instrument is remotely controlled, be extremely careful. The High Voltage Output is being turned On/Off with an external signal.

Safety Symbols

The product is marked with the following safety symbols.



Product will be marked with this symbol (ISO#3864) when it is necessary for the user to refer to the instruction manual in order to prevent injury or equipment damage.



Product marked with this symbol (IEC417) indicates presence of direct current.



Product will be marked with this symbol (ISO#3864) when voltages in excess of 1000V are present.

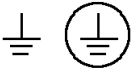

Indicates the grounding protect terminal, which is used to prevent electric shock from the leakage on chassis. The ground terminal must connect to earth before using the product.

Warning Procedure can cause hazard to human if the warning is neglected.

Caution Avoid product misuse. It may cause damage to the product itself and the DUT if the caution is neglected.

Note Important information or tips for the procedures and applications.

Warning Signal During Testing

“DANGER – HIGH VOLTAGE TEST IN PROGRESS, UNAUTHORIZED PERSONS KEEP AWAY”

Disposal

Do not dispose of electrical appliances as unsorted municipal waste, use separate collection facilities. Contact your local government for information regarding the collection systems available. If electrical appliances are disposed of in landfills or dumps, hazardous substances can leak into the groundwater and get into the food chain, damaging your health and well-being. When replacing old appliances with new one, the retailer is legally obligated to take back your old appliances for disposal.



2.1 General

Once the 7600 is powered up it is ready immediately for testing, at default test conditions, by pressing the **START** button. Power-up default conditions are discussed in paragraph 2.5.2. Any of these conditions and all other instrument operations can be changed by easy-to-use menu functions, for simplicity of understanding, descriptions and uses of all these functions refer to menu discussions in paragraph 2.6. The Contents list in the front of this manual should be used for quickly locating specify subjects of interest.

NOTE:

For optimum measurement results at specified accuracy a 30 minute instrument warm-up period is highly recommended.

2.2 Startup

Connect the instrument power cord to the source of proper voltage. **The instrument is to be used only with three-wire grounded outlets. The proper fuse must be installed as described in paragraph 1.6.2.**

Power is applied to the 7600 by pressing the **POWER** button on the front panel. The instrument runs a self test and any error messages are displayed accordingly.

2.3 Connection to Device Under Test

The 7600 unit employs a four terminal measurement configuration that permits easy, accurate and stable measurements and avoids mutual inductance, interference from measurement signals, noise and other factors inherent with other types of connections. To help maintain measurement integrity QuadTech makes available a number of accessory cable sets and fixtures for connection directly to the front panel BNC connectors. Refer to paragraph 1.5 for a list of available accessories.

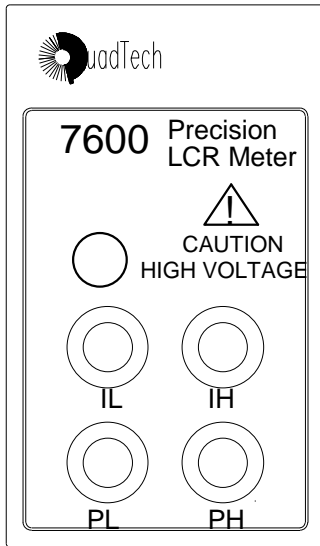

**Figure 2-1
Panel Layout**

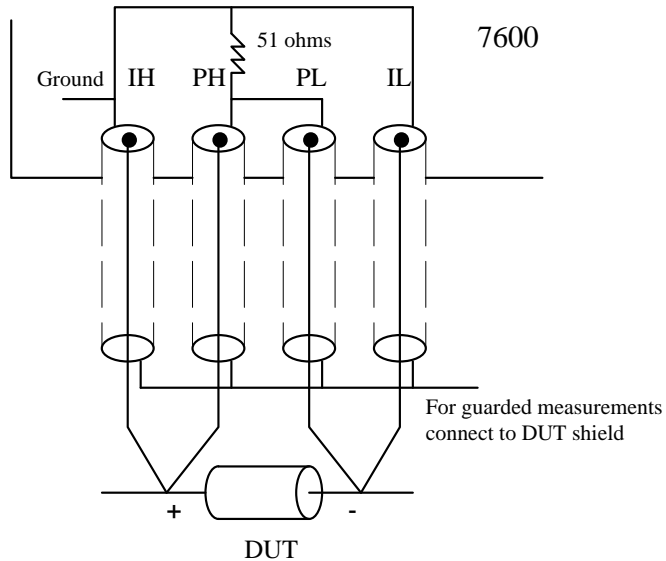

**Figure 2-2
Test Lead Configuration**

Figures 2-1 and 2-2 show the 7600 connector configuration and a typical four terminal connection to the device under test. **H and L on the 7600 denote polarity of AC test signal at the measurement terminals as well as + and - polarity of DC bias voltage when applied to the DUT.** Refer to paragraph 2.8 for information on operation and connection of QuadTech accessory cables and fixtures.

WARNING

When DC bias is applied, the PH connection carries a positive DC voltage with respect to ground.

2.4 Zeroing

Before making measurements, the 7600 should be zeroed to correct for test lead and/or fixture errors. During the zeroing process corrections are calculated and stored in instrument memory and applied to ongoing measurements. Measurement accuracy is specified at the end of the QuadTech one meter cable (7000-01). Open and short circuit zeroing should be done at the end of this cable. In order to maintain instrument accuracy with other cable lengths the instrument should be re calibrated using the QuadTech 7000-09 Calibration Kit and the alternate cable. Generally the unit should be zeroed at least once per day and each time test leads or fixture is changed. **It is not necessary to re-zero if the test frequency is changed.** The zeroing routine is accessed through the Utilities Menu as follows:

- Press **MENU** key
- Press **LEFT/RIGHT ARROW** to select Utilities menu
- Press **UP/DOWN ARROW** key for Open / Short
- Press **ENTER**

Follow the instructions shown on the LCD display for open and short circuit zeroing of test leads and/or fixture. During the **Open Test** the leads or fixture should be open with no component connected. During the **Short Test** leads should be connected or fixture shorted (using a clean copper wire, as short as possible). Refer to paragraph 2.6.5.4 as necessary for more detail. When zeroing, **Contact Check should be OFF, # to Average to 1 and Median OFF.**

2.5 Measurement Procedure

2.5.1 General

Whenever the 7600 is powered up it is ready immediately to begin measuring at default test conditions. Initially, these conditions will be set to factory default but can be changed by the user and stored to overwrite factory default. **To initiate a test once a device is connected press START**, the LCD display shows the measured results and test conditions similar to the illustration of Figure 2-3. For information on changing test conditions refer to paragraph 2-6 on Menu Functions.

NOTE:
For optimum measurement results at specified accuracy a 30 minute instrument warm-up period is highly recommended.

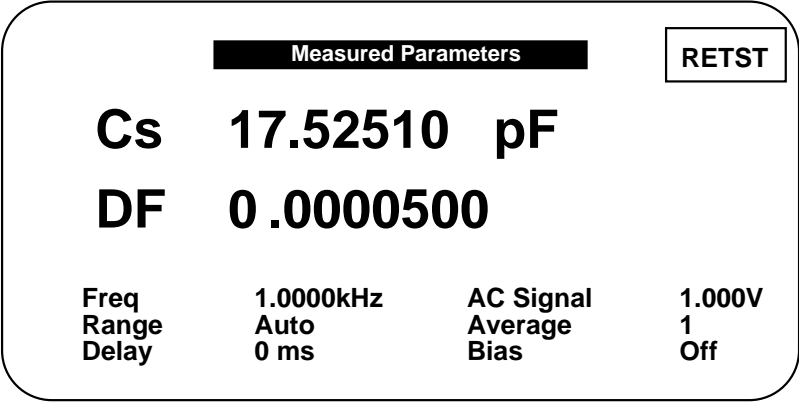

**Figure 2-3
 Measured Results Display**

2.5.2 Default Measurement Conditions

A set of default measurement conditions are initially established at the factory and stored in instrument memory. Default conditions are those that determine the instruments status on power up, thus the instrument is always set to a known state before any testing begins. These conditions can be changed by the user for tailoring to a specific application. Refer to paragraph 2.6.5.1 under Save Setup on the Utilities menu.

Factory default measurement conditions are:

Under Setup Menu

Primary Parameter - Auto
Secondary Parameter - None
Frequency - 1 kHz
AC Test Signal - 1V
DC Bias Voltage - Off
Range Hold - Off
Range Locked - 0
Measurement Accuracy - Medium
Delay Time - 0
to Average - 1
Contact Check - Off

Under I/O Menu

Display Type - Measured Parameters
Nominal Value - None
Result Format - Engineering
Trigger - External
Handler - On
RS-232 - Disable
IEEE - Disable
Print Results - Off
Results to Floppy - Off

Under Analysis Menu

Binning - None
Test Sequencing - Off
Parameter Sweep - Off
Median - Off
Distort Detect - On
Load Correction - Off

Under Utilities Menu

Lockout - Off
Backlite - On

2.6 Menu Functions

2.6.1 General

All programmable functions of the Model 7600 are controlled by easy to use menu displays. The user enters the menu mode by selecting the **MENU** key which calls up four top level menus, **Setup**, **I/O**, **Analysis** and **Utilities**. Each one of these is comprised of a sub menu list whose functions are described in detail below. Finding ones way around the menu listing is accomplished in a fashion similar to an Automatic Teller Machine (ATM) using the **UP**, **DOWN**, **RIGHT** and **LEFT** arrow keys as indicated on the adjacent LCD display. **A highlighted menu function can be controlled by selecting the ENTER key, making the desired entry or selection and pressing ENTER again to implement.**

2.6.2 Setup Menu

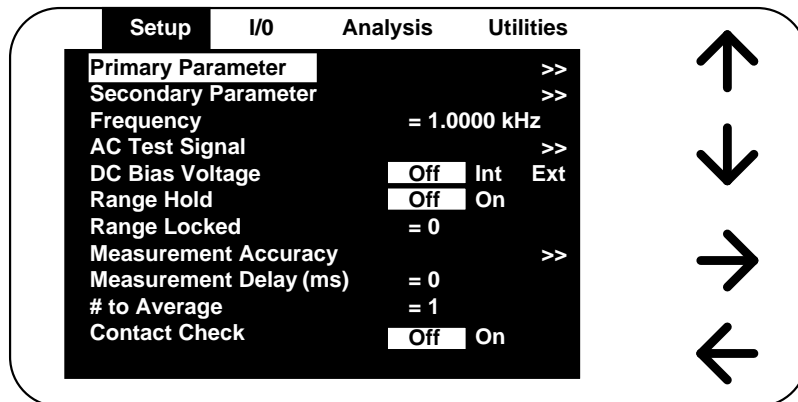

Figure 2-4
Setup Menu

The first of the four main menus is **Setup**, shown above. Each function controls a 7600 measurement condition and is described in detail below.

| | | | |
|-------------------------------------|------------|-----------------|------------------|
| Setup | I/O | Analysis | Utilities |
| Primary Parameter | _____ | | Auto |
| Secondary Parameter | _____ | | Cs |
| Frequency - (numeric entry) | | None | Cp |
| AC Test Signal - Voltage | | DF | Ls |
| - Current | | Q | Lp |
| - Value - (numeric entry) | | ESR | Rs |
| DC Bias Voltage - Off | | θ | Rp |
| - Int | | Rs | DF |
| - Ext | | Rp | Q |
| Range Hold - Off | | Gp | Z |
| - On | | Cs | Y |
| Range Locked - (numeric entry) | | Cp | θ |
| Measurement Accuracy - Fast | | Ls | ESR |
| - Medium | | Lp | Gp |
| - Slow | | Z | Xs |
| Measurement Delay - (numeric entry) | | Y | Bp |
| # to Average - (numeric entry) | | Xs | |
| Contact Check - Off | | Bp | |
| - On | | | |

2.6.2.1 Primary Parameter

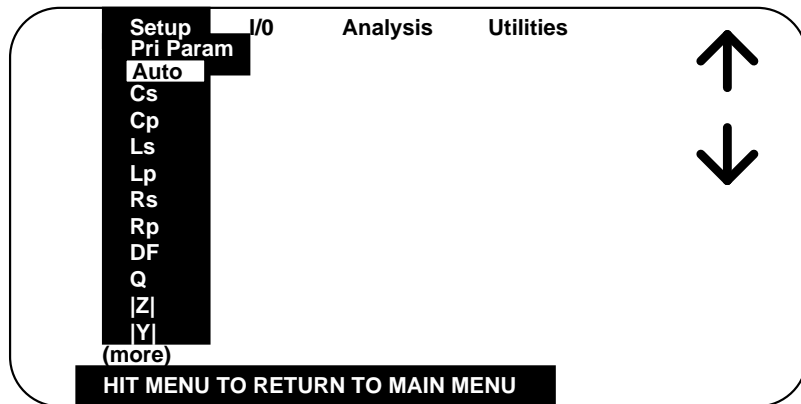

Figure 2-5
Primary Parameters

Additional Parameters not shown and selected by UP/DOWN arrow keys include: θ , |ESR|, Gp, Xs, Bp

Any combination of two parameters can be measured and displayed simultaneously on the 7600, one referred to as the **Primary** (displayed first) and the other the **Secondary**. The instrument as powered up provides a default primary parameter selection of Auto, a feature which enables any passive component to be measured without knowing what type of component it is. Depending on the component type the primary and secondary default could be Cs & DF, Rs & Q, or Ls & Q. The parameter selection can be chosen by the operator through menu selection as shown in Figure 2-5 above. Besides Auto the following selections are possible and discussed in more detail below.

| | |
|------------------------------------|---|
| Cs - Capacitance in farads | Z - Impedance in ohms |
| Cp - Capacitance in farads | Y - Admittance in siemens |
| Ls - Inductance in henries | θ - Angle in degrees |
| Lp - Inductance in henries | ESR - Equivalent series resistance in ohms |
| Rs - Resistance in ohms | Gp - Conductance in siemens |
| Rp - Resistance in ohms | Xs - Reactance in ohms |
| DF - Dissipation Factor (no units) | Bp - Susceptance in siemens |
| Q - Quality Factor (no units) | |

s = series equivalent circuit

p = parallel equivalent circuit

An impedance that is neither a pure resistance nor a pure reactance can be represented at any specific frequency by either a series or a parallel combination of resistance and reactance. Such a representation is called an equivalent circuit. The value of the primary measurement of a device depends on which equivalent circuit, series or parallel, is chosen to represent it. The manufacturer or user of a device specifies how a device is to be measured (usually series) and at what frequency. If this is not known, be sure to specify if the results were series or parallel and what the measurement frequency was.

Series and parallel equivalent circuits for a lossy inductor and lossy capacitor are shown in Figure 2-6.

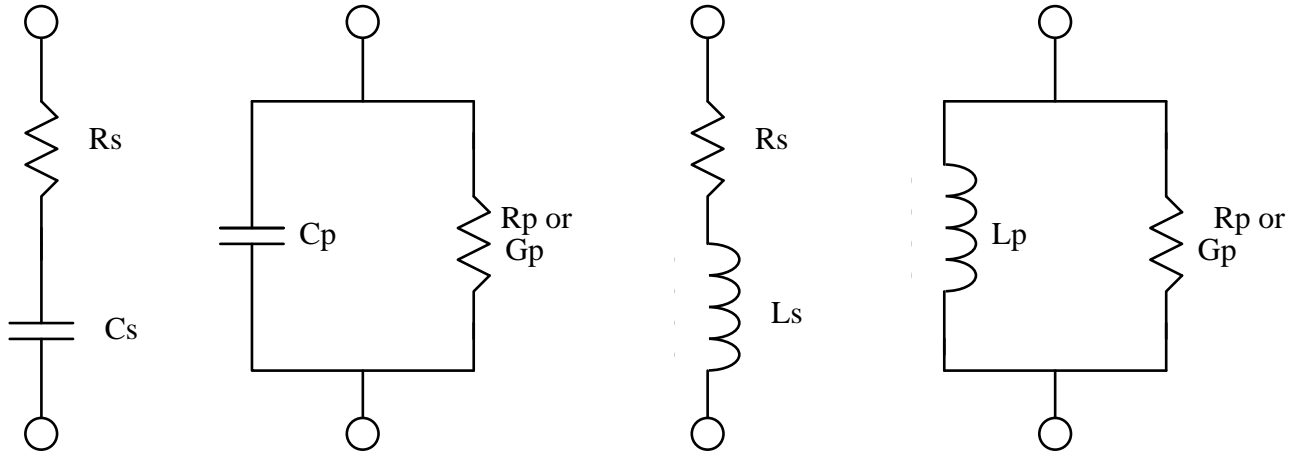

Figure 2-6

Series and Parallel Circuits for both Capacitive and Inductive Impedances

Impedance is the parameter used to characterize electronic components, materials and circuits. Impedance $|Z|$ is defined as the opposition a device or circuit offers to the flow of ac current at a particular frequency and generally represented as a complex quantity consisting of a real part (resistance, R) and imaginary part (reactance, jX). Impedance can be expressed using the rectangular coordinate form ($R + jX$) or polar form as magnitude and phase angle ($|Z| \angle \theta$). Figure 2-7 shows the mathematical relationship between R , X , $|Z|$, and θ for both inductive and capacitive devices. In some cases it becomes mathematically practical to represent impedance using the reciprocal where $1/|Z| = |Y| = G + jB$, where $|Y|$ represents admittance, G conductance, and B susceptance. This mathematical relationship is shown in Figure 2-8 for inductive and capacitive devices.

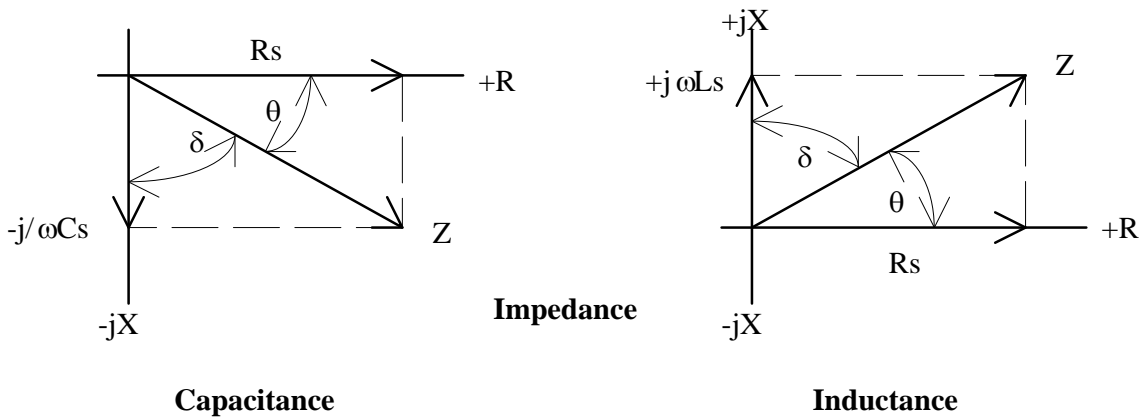

Figure 2-7

Phase Diagrams of Impedance

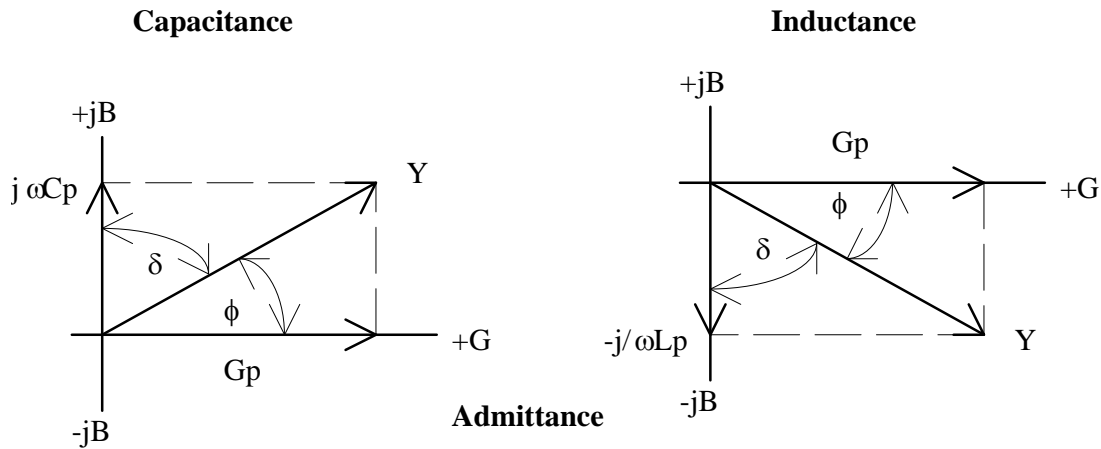

Figure 2-8
Phase Diagrams of Admittance

Quality factor (Q) is used as a measure of a reactance's purity (how close it is to being a pure reactance, i.e. no resistance) and defined as the ratio of the energy stored in a device to the energy dissipated by the device. Q is dimensionless and is expressed as $Q = X/R = B/G$. From Figure 2-8 one can see that Q is the tangent of the angle θ . Q is commonly applied to inductors and for capacitors the term generally used to express purity is Dissipation Factor (D), which is the reciprocal of Q .

Any parameter, primary or secondary, can be chosen as the default parameter at power up, refer to paragraph 2.6.5.1, changing default conditions.

2.6.2.2 Secondary Parameter

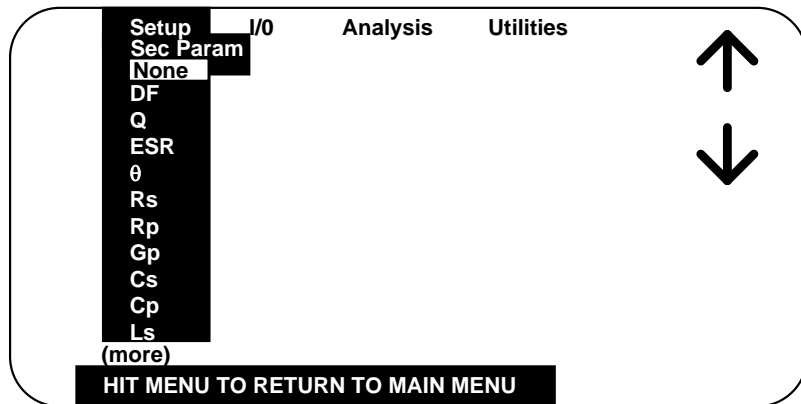

Figure 2-9
Secondary Parameter

Additional Parameters not shown and selected by UP/DOWN arrow keys include: **Lp**, **|Z|**, **|Y|**, **Xs**, **Bp**

As in the primary parameter selection, any one parameter can be chosen by the operator for display. The instrument as powered up provides a default secondary parameter. When the default primary parameter is Auto the secondary parameter is dependent and determined by it. If the primary default is Cs the secondary defaults to D. If the primary default is Ls or Rs the secondary defaults to Q. The parameter selection can be chosen by the operator through menu selection as shown in Figure 2-9.

2.6.2.3 Frequency

Numerical entry accepts up to **five digits with decimal**, of the desired test frequency between 10 Hz and 2 MHz. Resolution of setting is 0.1 Hz from 10 Hz to 10 kHz, 5 digits above 10 kHz and 4 digits above 100 kHz. The accuracy of the frequency programmed is +/- (0.25% + 0.02 Hz).

Units of frequency, **Hz**, **kHz**, or **MHz** are selected by the **UP/DOWN** arrow keys.

NOTE:

In order for the instrument to perform high frequency measurements (i.e. above 50 kHz), frequencies are grouped into ranges. The size of these ranges is dependent upon many factors: including the DDS clock frequency, the frequency programmed, and the frequency accuracy resolution specified for the unit. Thus when a user programs a "test frequency" the actual frequency may be +/- (0.25% + 0.02 Hz).

2.6.2.4 AC Test Signal

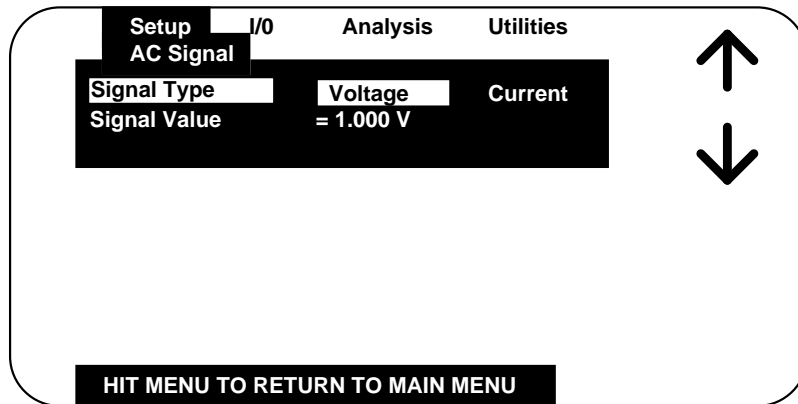

Figure 2-10
AC Test Signal

Allows selection of the AC Signal Type as a **Voltage** source or **Current** source, RIGHT/LEFT arrow keys.

With Signal Type selected as **Voltage**, Signal Value accepts entry of a value between **.020 and 5 volts*** (open circuit) in 0.005 V steps.

With Signal Type selected as **Current**, Signal Value accepts entry of a value between **.00025 and .1 amp** (short circuit) in .00005 amp steps.

Numerical values can be entered directly with units. Units for voltage value, **mV** or **V** and units of current value, **μA**, **mA** or **A** are selected by the UP/DOWN arrow keys. Any **numerical entries with resolution greater than .005 (5 mV) for voltage or .00005 (50 μA) for current will be truncated or ignored.**

In voltage mode the selected voltage is maintained at the instrument test terminals with the terminals open, but not necessarily at the device under test. In current mode the selected current is maintained at the device under test, independent of changes in the device's impedance. It should be noted that even though the maximum programmable current is 100 mA **the instrument is limited to a compliance voltage of 3 volts* in current mode**, i.e. (I) times (Z) must be less than 3 volts otherwise erratic measurement results could occur.

The current required to test a device may exceed 100 mA if the source voltage is programmed to greater than 2.5 V. To determine the current required use the following formula:

$$I = V_{\text{prog}} / \sqrt{(25 + R_{\text{dut}})^2 + (X_{\text{dut}})^2}$$

if the current is greater than 100 mA reduce the program voltage, otherwise unpredictable measurement results may occur.

* 1 volt above 500 kHz, 0.5 volts above 1 MHz

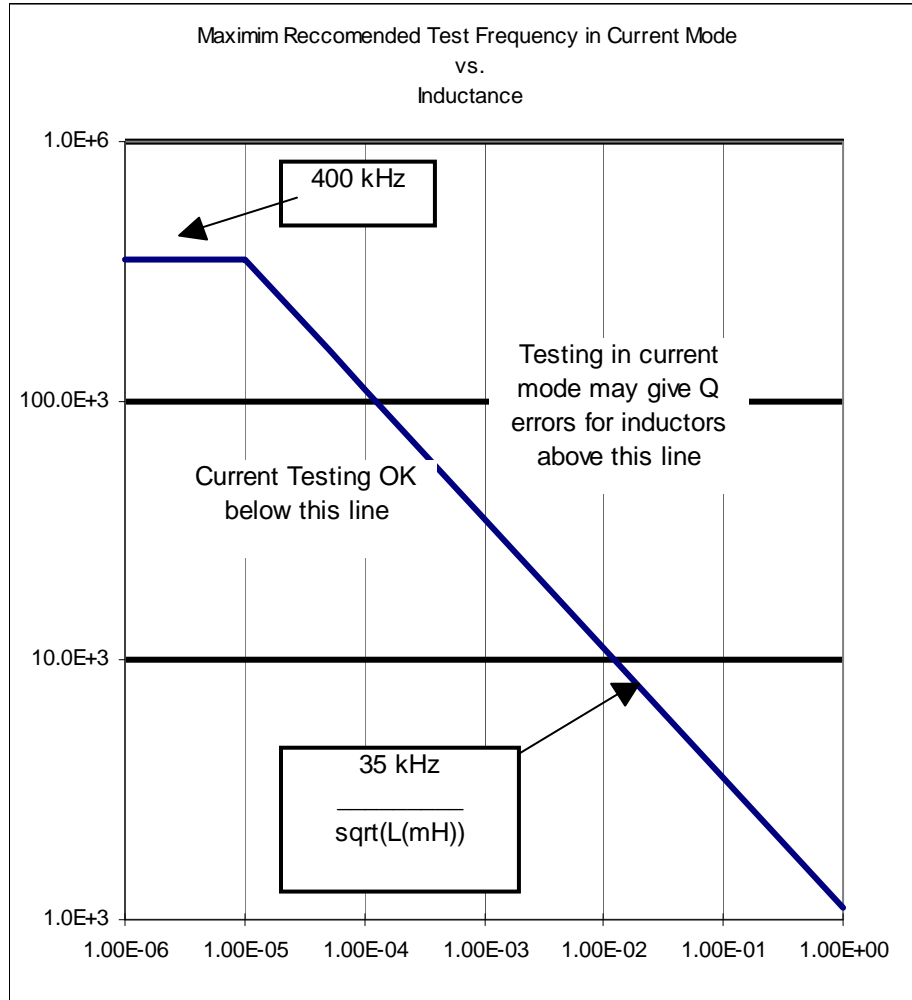

**Maximum Test Frequency vs. Measured Inductance
(In Current Mode)**

2.6.2.5 DC Bias Voltage

--- Allows selection of a dc Bias Voltage of **Off, Internal or External**.

- **Off** - When selected **no dc bias** voltage is applied to the device under test.
- **Int** - When selected an internal bias voltage of **2 volts** is applied to the device under test. Internal bias can not be programmed if the AC Test Signal is programmed for > 4V at 500kHz.
- **Ext** - When selected an external bias voltage between **0 and +/-200 volts** can be applied to the device under test by way of the rear panel external bias connection.

WARNING

Make sure the **AC test Signal is selected for VOLTAGE and not Current** before switching to INT (internal) or EXT (external) bias. This also applies to the instrument's Default setup at power-up or any setups recalled from memory, they **MUST be set to VOLTAGE** before applying bias. If programmed to CURRENT the instrument can sustain damage from any external source or from a charge stored on the device under test.

WARNING

When using external bias, unit must be programmed for EXT bias before the external bias supply is connected to the 7600.
External bias supply must be returned to zero volts and turned off before switching back to the OFF or INT mode.

The **BIAS ON indicator**, adjacent to the BNC measurement terminals, serves to indicate if external bias has been called for. It indicates that external bias connections have been switched in, **but not necessarily the presence of external bias.**

When dc bias is to be applied to a device observe the correct polarity when connecting the bridge or inserting the device in a test fixture. **Bias POSITIVE polarity is applied to the high terminals (PH, IH), and bias NEGATIVE polarity applied to the low terminals (PL, IL).** It is good practice to wait approximately 1 second after initiating a measurement before taking a reading, this allows the device to stabilize after bias is applied. When the instrument is triggered remotely, a programmed delay is advisable to ensure that the device has stabilized.

If bias is required at voltages other than the internal 2 volts, an external bias can be used as discussed below.

- **Be sure that the voltage does not exceed +/-200 volts.**
- A current limiting voltage supply is recommended, with a limit set at 200 mA.
- **The bias supply must be floating, DO NOT connect either side to ground.** When using a single polarity supply for positive or negative biasing, observe proper polarity when connecting to the 7600. For positive bias the positive output of the supply must be connected to **Bias Voltage +** and the negative to **Bias Voltage -**. The opposite is true for negative bias, the negative output of the supply must be connected to the **Bias Voltage +** and the positive to **Bias Voltage -**.
- Generally the external circuit must provide switching for both application of bias after the device is connected and discharge before it is removed.
- A well-filtered supply is recommended. Hum can affect some measurements, particularly at power line frequencies.

When applying a bias voltage there are effects to be aware of in watching for stabilization of the DUT: voltage and capacitance. Besides charging to a final voltage, there is also the stabilization of capacitance value itself. For example, some electrolytic capacitors respond slowly to a change in applied voltage, therefore the capacitance can be changing well after the voltage is stable. In general DC bias should only be applied to capacitors, **unreliable measurement results can occur if DC bias is applied to low impedance devices**. When applying external bias on capacitors below 200pF with an AC signal level below 100mV the instrument can exhibit excessive noise.

2.6.2.6 Range Hold

Allows selection of Range Hold **Off** or **On**. **To eliminate operator errors in range setting and ensure specified instrument accuracy the 7600 Range Hold should generally be left Off**. There may be exceptions to this when repetitive measurements are to be made over a concentrated range of values and there is a desire to reduce test time by eliminating range switching.

- **Off** - When selected the instrument automatically **selects the optimum range** for the test voltage and test frequency selected and the impedance being measured.
- **On** - When selected the **range is held** based on the one currently selected, 1 through 59 in voltage mode or 33 through 159 in current mode. The one currently selected is best determined by measuring the device with Range Hold to Off. Measured results outside the bounds of a selected range will be indicated by an **OVER RANGE** or **UNDER RANGE** display message.

NOTE:

The 7600 unit provides an extensive array of range switching based on the user test conditions selected and impedance being measured. Refer to paragraph 2.6.2.7.

One of the most important uses of the range holding capability is to avoid range changes when the component is removed from a fixture when repetitive internal triggering is selected. With no component connected the instrument can go into a range search and time is lost when the next component is connected. Another use of range hold occurs when measuring components of the same nominal value whose actual values spread across the boundary of two ranges. If allowed to auto range, the units and decimal point can change with the range and confuse the operator. **It is important to note that when a range is held which is not the range the instrument auto ranging would have selected, some accuracy may be sacrificed.**

Under certain circumstances high Q inductors can cause extraneous overload conditions if they are tested at frequencies where the inductor resonates with the test leads. This situation can be avoided by one or more of the following: test at a voltage substantially below full scale voltage for a given range; use low capacitance cables; or test at a frequency below the resonant frequency of the inductor with the test leads.

2.6.2.7 Range Locked

Accepts entry of selected measurement ranges between **0 and 59 (as listed below)**, 0 for no range locked and others for the selected range. Measurement ranges are a function of the impedance being measured (Z), selected test frequency (F) and ac test voltage (V). For best measurement results the instrument is generally recommended to operate with Range Hold to **Off** and Range Locked to **0**. It is possible to calculate a range, based on Z, F and V, as detailed below.

AC Signal Voltage Mode

| Measurement Range #'s | | | |
|-----------------------|----|----|----|
| 1 | 17 | 33 | 49 |
| 2 | 18 | 34 | 50 |
| 3 | 19 | 35 | 51 |
| 5 | 21 | 37 | 53 |
| 6 | 22 | 38 | 54 |
| 7 | 23 | 39 | 55 |
| 9 | 25 | 41 | 57 |
| 10 | 26 | 42 | 58 |
| 11 | 27 | 43 | 59 |

Determine Range where $R\# = R1 + R2 + R3$

where R1 = 1 and $K^* = 10 \mu\text{A}$ if $F < 25 \text{ kHz}$ and $I < 10 \mu\text{A}$
= 17 and $K^* = 160 \mu\text{A}$ if $F < 200 \text{ kHz}$ and $I < 160 \mu\text{A}$
= 33 and $K^* = 2.56 \text{ mA}$ if $I < 2.56 \text{ mA}$
= 49 and $K^* = 40 \text{ mA}$ if $I \geq 2.56 \text{ mA}$

* value for K required in calculation of R3 below

$$I = \frac{V_i}{Z + 25}$$

$V_i = 10\text{V}$ if $V \leq 0.1\text{V}$
= V if $V > 0.1$ and < 1.01
= $V/5$ if ≥ 1.01

$V =$ programmed ac test voltage

$Z =$ impedance value Z in ohms of the device under test (refer to Figures 2-11 and 2-12 to help determine Z in terms of capacitive and inductive reactance).

where R2 = 0 if $(I)(Z) > 0.25$
= 1 if $(I)(Z) > 0.1$
= 2 if $(I)(Z) > 0.025$

where R3 = 0 if $I / K > 0.25$
= 4 if $I / K > 0.1$
= 8 if $I / K > 0.025$

Note: above 1.5 MHz R2 and R3 are always 0 (zero)

AC Signal Current Mode

| Measurement Range #'s | | | |
|-----------------------|----|-----|-----|
| 33 | 49 | 133 | 149 |
| 34 | 50 | 134 | 150 |
| 35 | 51 | 135 | 151 |
| 37 | 53 | 137 | 153 |
| 38 | 54 | 138 | 154 |
| 39 | 55 | 139 | 155 |
| 41 | 57 | 141 | 157 |
| 42 | 58 | 142 | 158 |
| 43 | 59 | 143 | 159 |

Determine Range where $R\# = R + R1 + R2 + R3$

where R = 33 and $R_s = 400\Omega$ if $I \leq 2.2\text{mA}$
 = 49 and $R_s = 25\Omega$ if $I > 2.2\text{mA}$

I = programmed ac test current

where R1 = 0 and $V_s = 1.0$ if E_{DUT} or $E_{DET} \leq 1.0$
 = 100 and $V_s = 5.0$ if E_{DUT} or $E_{DET} > 1.0$

$E_{DUT} = (I)(Z)$ this value must be less than 3.0, reference paragraph
 2.6.2.4 AC Test Signal

$E_{DET} = (I)(R_s)$

Z = impedance value Z in ohms of the device
 under test (refer to Figures 2-11 and 2-12
 to help determine Z in terms of capacitive
 and inductive reactance).

where R2 = 0 if $E_{DUT}/V_s > 0.25$
 = 1 if $E_{DUT}/V_s \leq 0.25$
 = 2 if $E_{DUT}/V_s \leq 0.1$

where R3 = 0 if $E_{DET}/V_s > 0.25$
 = 4 if $E_{DET}/V_s \leq 0.25$
 = 8 if $E_{DET}/V_s \leq 0.1$

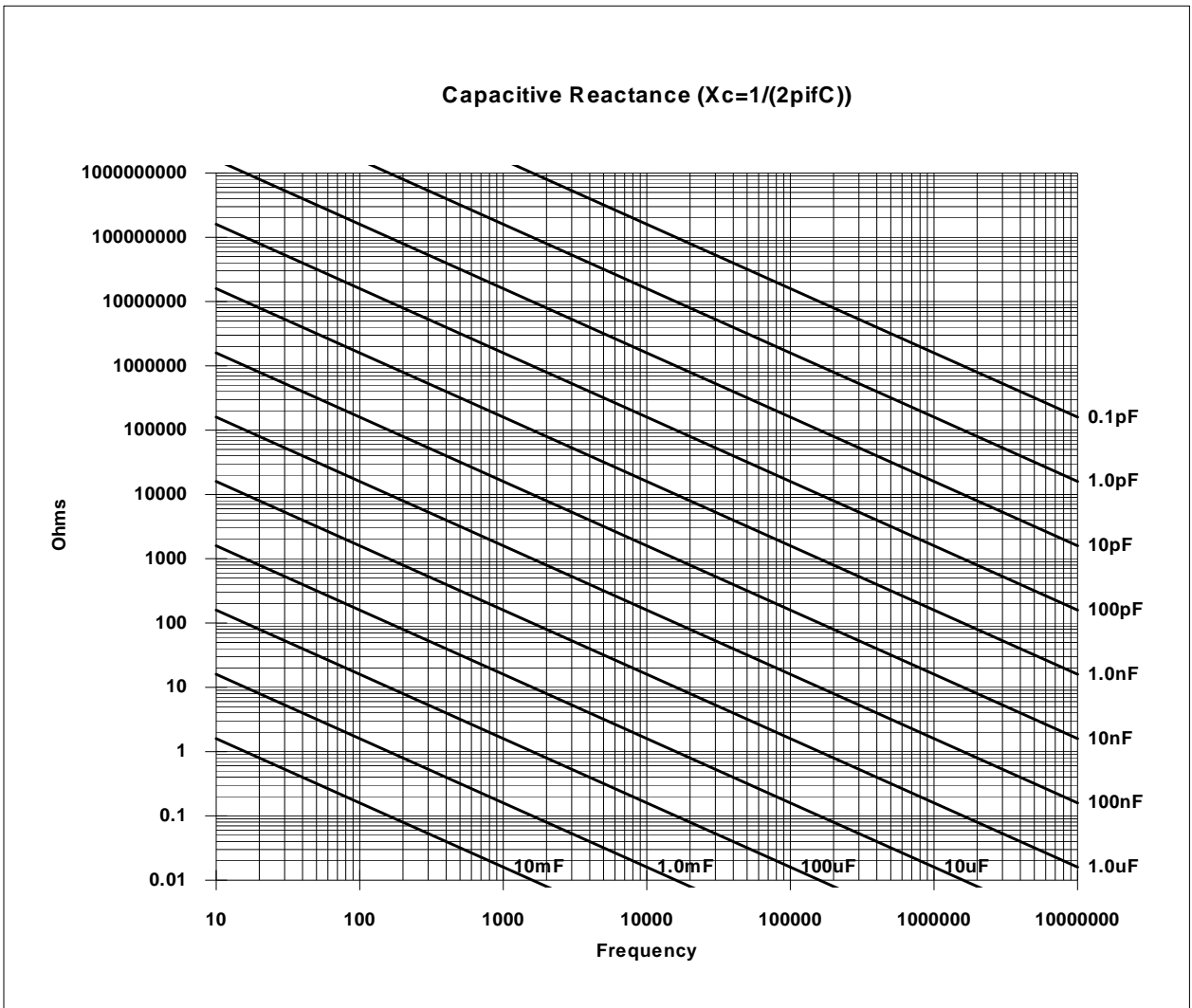

Figure 2-11
Capacitive Reactance vs. Frequency

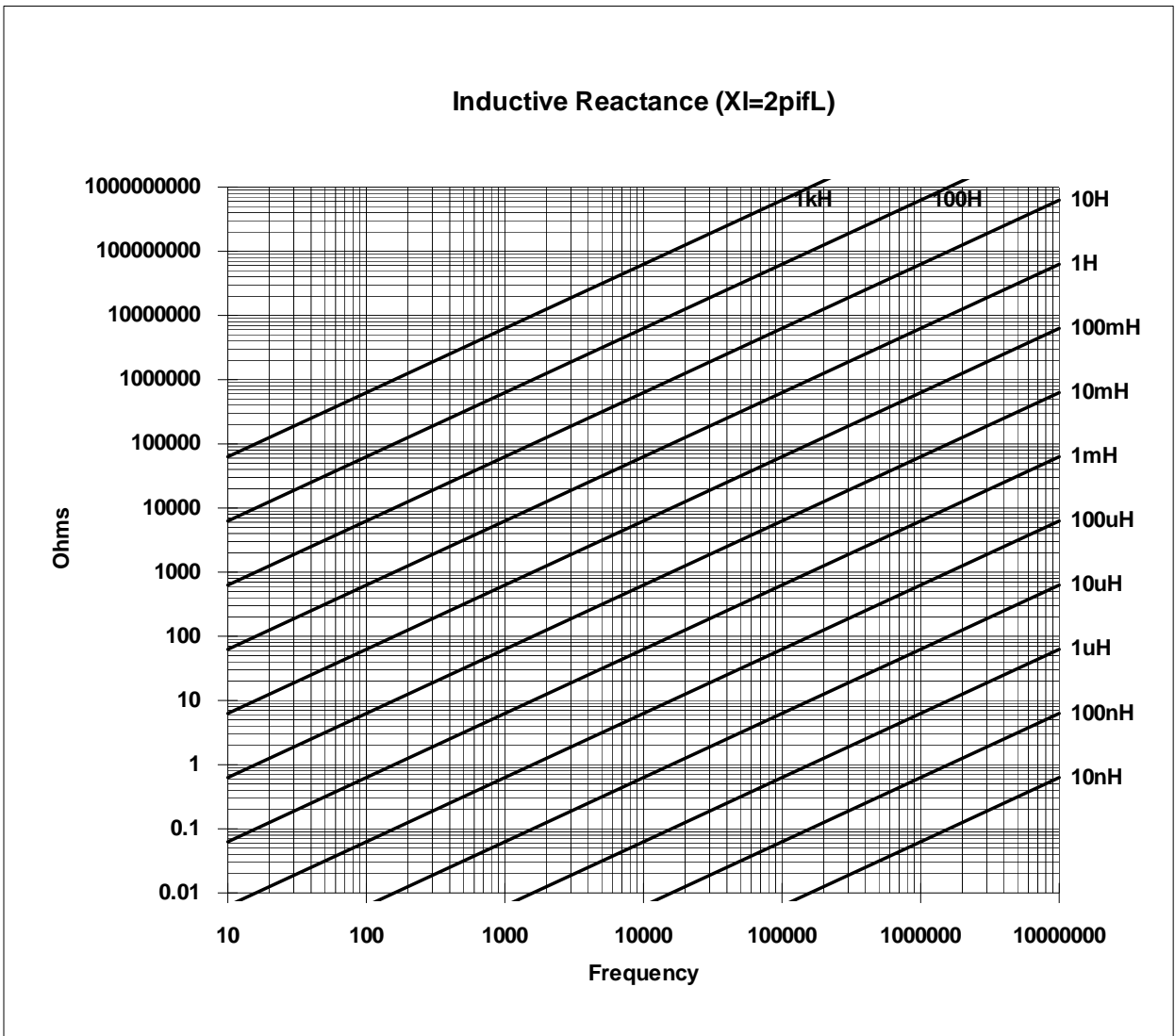

Figure 2-12
Inductive Reactance vs. Frequency

2.6.2.8 Measurement Accuracy

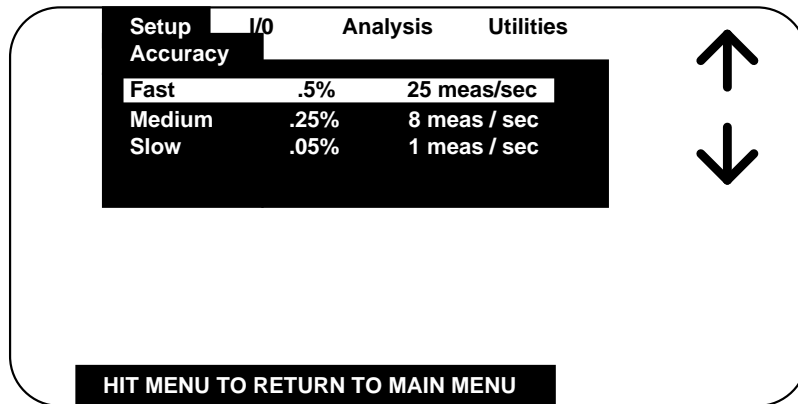

Figure 2-13
Measurement Accuracy

Allows selection of Measurement Accuracy of **Fast**, **Medium** or **Slow**.

There is a tradeoff of measurement speed vs. accuracy. The meter will make a more precise and accurate measurement at a slower rate. The speed/accuracy tradeoff is as follows:

- **Fast** - Measurement time of 40 ms (or one frequency cycle, whichever is longer), nominal accuracy of **0.5%**.
- **Medium** - Measurement time is 125 ms, nominal accuracy of **0.25%**.
- **Slow** - Measurement time is 1 sec, nominal accuracy of **0.05%**.

NOTE:

Measurement times may be longer depending on frequency and other test conditions.

One complete cycle of stimulus voltage is required for measurement.

For example: at 10 Hz, 100 ms (1 cycle) is required just to collect data.

2.6.2.9 Measurement Delay

Accepts entry of a delay time between **0 and 1000** in 1 ms steps. This is a programmable delay time from the internal or external trigger command to the start of the measurement. In many cases it is helpful to have a time delay before actually starting to take data. Such a delay allows time for switching transients or mechanical handling to settle.

2.6.2.10 # to Average

Accepts entry of the number of measurements to Average between **1 and 1000**. If the entered value is 1, averaging is disabled and the display is updated with each individual measurement. If the average is 2 to 1000 the final average value is displayed at the end of the measurement cycle and held until the end of the next measurement cycle.

Measurement accuracy can be improved as noted below and will be indicated on the AutoAcc display (but never less than 0.05% for primary parameter or 0.0005 for secondary parameter).

If the number to average is greater than 1:

Divide the primary accuracy by the square root of the number to average.

Divide the secondary accuracy by the square root of the number to average.

2.6.2.11 Contact Check

Allows selection of Contact Check **Off or On**. When on, any detection of contact failure or open circuit to the device under test will be indicated prior to the measurement. A contact failure is considered to be an open circuit greater than the open circuit calibration of the instrument. **Contact Check is generally recommended in automatic handler/production type applications with the 7600. For Contact Check operation the Range Hold must be selected ON**, paragraph 2.6.2.6.

NOTE:

A contact check is possible on three of the four Kelvin connections by a loss of voltage detecting technique, a failure on the PL connection can't be detected since it is at virtual ground potential, internal to the instrument. The contact check is likely to be unreliable when measuring devices of less than 100 m Ω of impedance.

2.6.3 I/O Menu

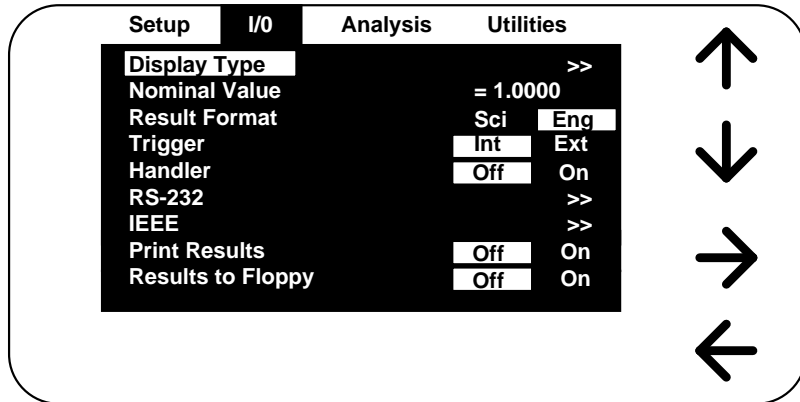
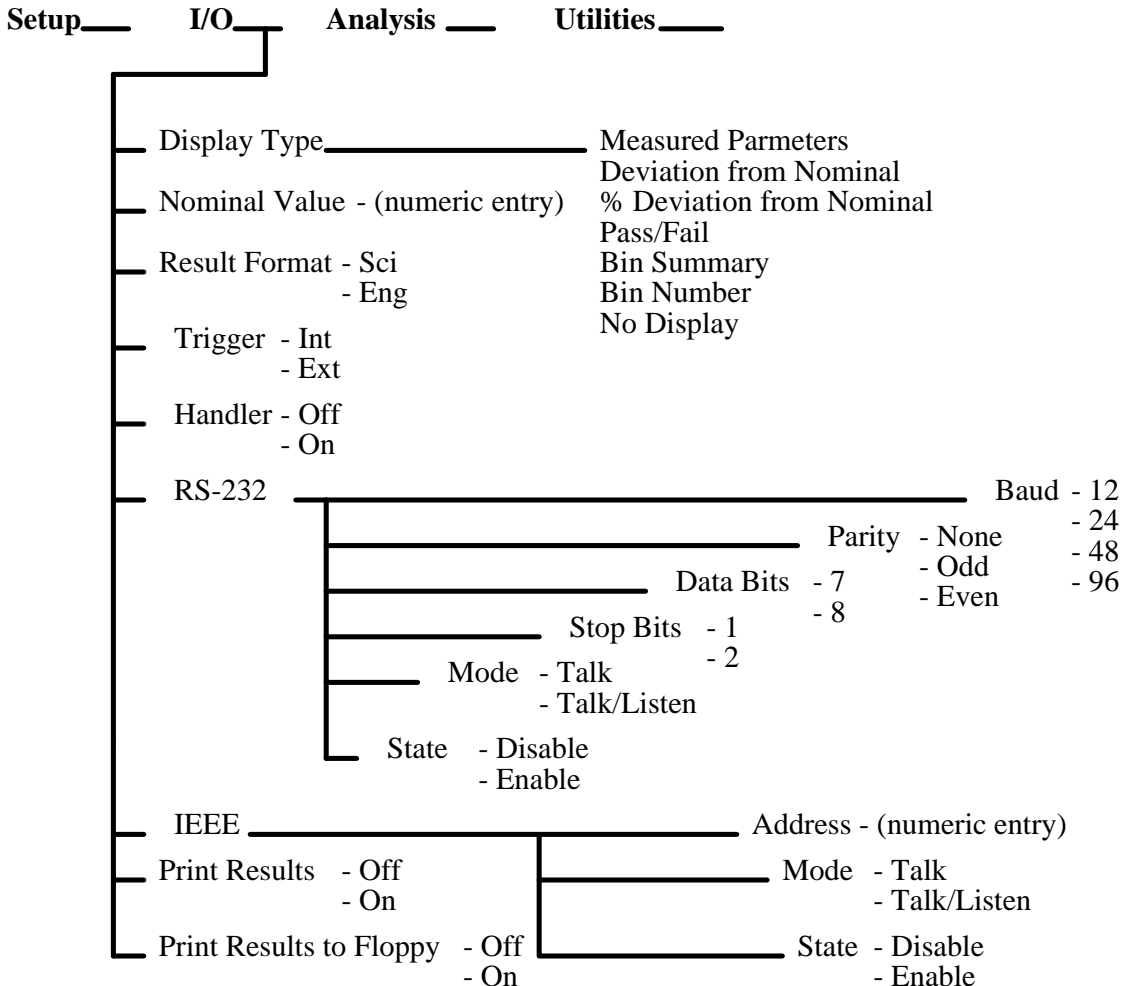

Figure 2-14
I/O Menu

The second of the four main menus is **I/O**, shown above. Each function controls measurement results or instrument I/O interface and is described in detail below.



2.6.3.1 Display Type

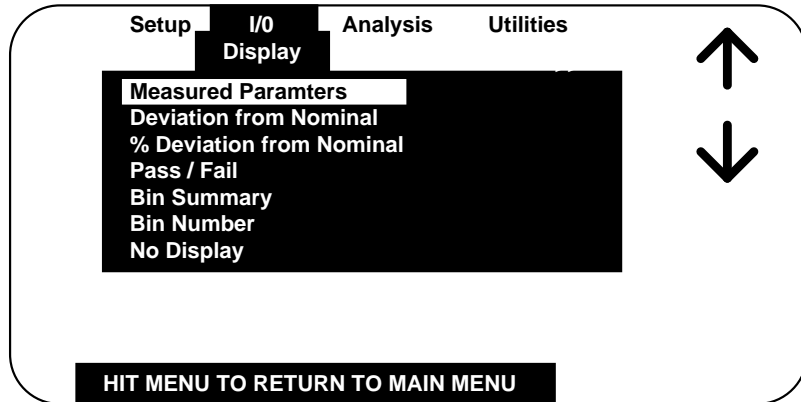

Figure 2-15
Display Type

Allows selection from seven different modes of measurement display, these being:

- **Measured Parameters** - Display is the measured values of both the primary and secondary parameter, displayed along with decimal point and units. Each value is shown with **7 digits of resolution** (6 digits if the result is negative). The message **Measuring** is shown when a measurement is in process, with the exception of short measuring times.

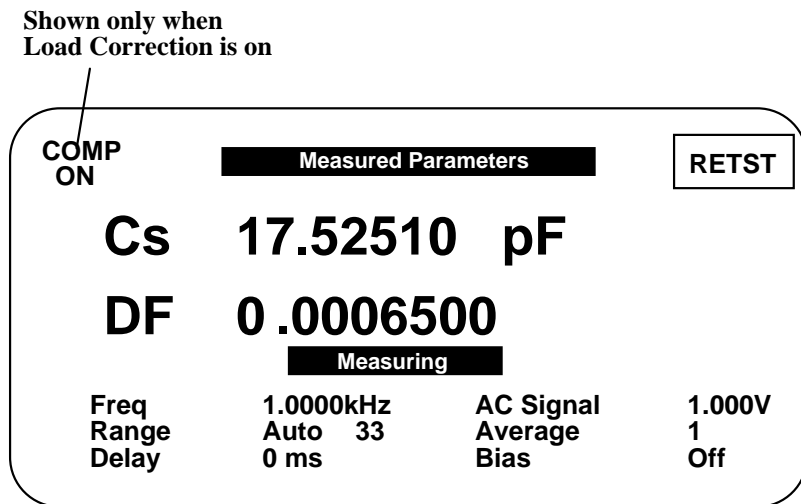

Figure 2-16
Measured Parameters Display

- **Deviation from Nominal** - Display is the difference in value above or below a stored nominal value for the primary parameter (also refer to paragraph 2.6.3.2). It should be noted that the nominal value is only shown in this display and the % Deviation display (Figure 2-18).

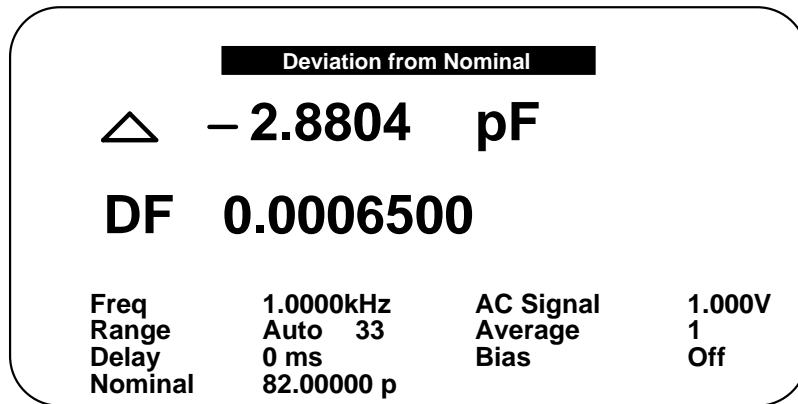

Figure 2-17
Deviation from Nominal Display

- **% Deviation from Nominal** - Display is the measurement in terms of a percent difference above or below (-) a stored nominal value (also refer to paragraph 2.6.3.2). It should be noted that the nominal value is only shown in this display and the Deviation from Nominal display (Figure 2-17).

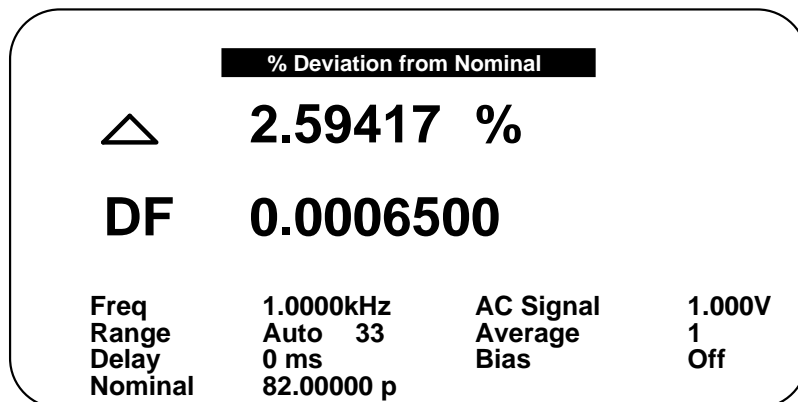
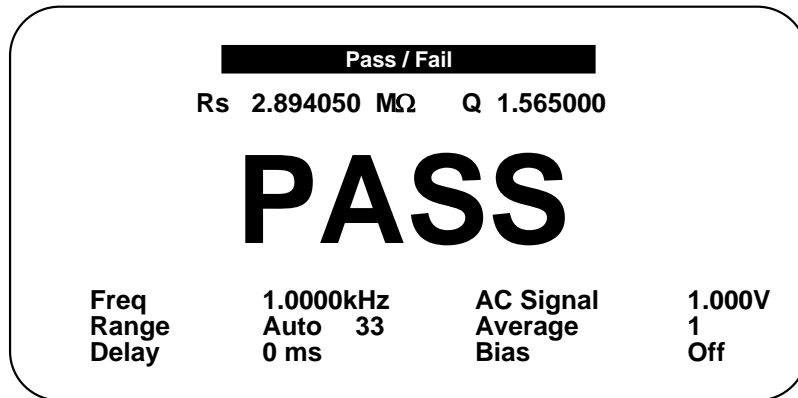

Figure 2-18
% Deviation from Nominal Display

- **Pass/Fail** - Display is measured results as a pass or fail only based on entered binning limits.



**Figure 2-19
PASS/FAIL**

- **Bin Summary** - Display is a summary of the entered bin limits and the total number of measurements made which meet the requirements of that bin since the bin counter was last reset.

| Bin | Low LIMIT | High LIMIT | Total |
|----------------|-----------------------|-----------------|------------|
| 1 | 90.00 k Ω | 110.00 k Ω | 250 |
| 2 | 100.00 k Ω | 120.00 k Ω | 100 |
| 3 | 110.00 k Ω | 130.00 k Ω | 90 |
| 4 | 120.00 k Ω | 140.00 k Ω | 80 |
| 5 | 130.00 k Ω | 150.00 k Ω | 75 |
| 11 | PRI Pass SEC Fail LOW | | 60 |
| 12 | PRI Pass SEC Fail HI | | 55 |
| 13 | PRI Fail SEC Pass | | 50 |
| 14 | PRI Fail SEC Fail | | 20 |
| 15 | NO CONTACT | | 5 |
| Totals: | Pass 595 | Fail 190 | 785 |

**Figure 2-20
Bin Summary Display**

- **Bin Number** - Display is a bin assignment, along with the currently programmed test conditions, for the most recent measurement result.

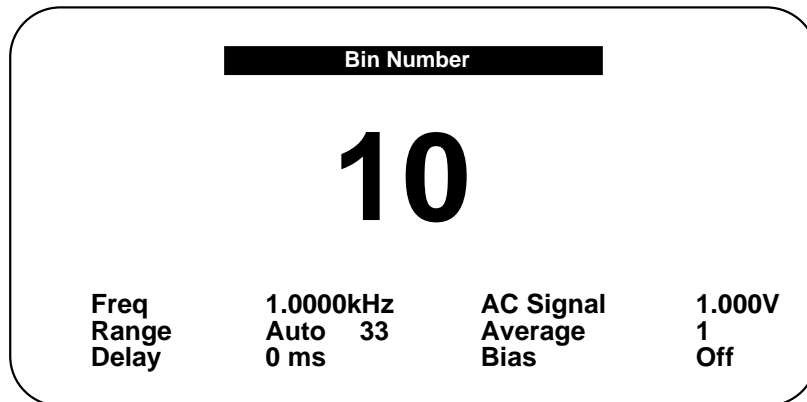

**Figure 2-21
Bin Number Display**

- **No Display** - Instrument display is inhibited from indicating any measurement results. This is sometimes used for security reasons or for the purpose of reducing test time during remote operation.

2.6.3.2 Nominal Value

Allows entry of a Nominal Value for the primary parameter, which is the **basis for the measurement result in Deviation or % Deviation**. Accepts numerical entry up to seven digits with decimal. Units are selected by the UP/DOWN arrow keys and determined by the primary parameter selection, i.e. in Farads, Ohms, Henries, etc.

NOTE:

The nominal value has no relationship to nominal values entered during binning setup.

2.6.3.3 Result Format

Allows selection from two different measurement result formats **SCI and ENG**, for scientific or engineering units. Scientific units are expressed as an exponent and engineering units are expressed in ohms for resistance, farads for capacitance, henries for inductance, etc. For example e^3 in scientific units can be expressed as kohms in engineering units or e^{-3} in scientific units can be expressed as mohms in engineering units, this is strictly user preference and convenience.

When scientific units are selected the results will always be displayed as some number of digits with decimal, exponent and units. When engineering units is selected the results will be displayed as some number of digits with decimal and units.

2.6.3.4 Trigger

Allows selection of two trigger modes, **Internal** or **External**.

- Internal - Measurement trigger is **automatic and continuous** once initiated with a START. If the STOP key is pressed in the middle of a measurement (with Range Hold set to OFF) any measurement range indication or displayed results is invalid.
- External - Measurement trigger is under **remote control** via front panel, handler, RS 232 or IEEE-488 interface.

2.6.3.5 Handler Interface

Allows user to turn Handler Interface function **On or Off**. When On is selected the input and output lines on the rear panel I/O interface connector are acknowledged, if Off is selected they are ignored.

2.6.3.6 RS-232 Interface

The screenshot shows a menu titled 'RS-232' under the 'I/O' tab. The menu items and their current selections are:

| Parameter | Options | Selected |
|-----------|-------------------|-------------|
| Baud | 12, 24, 48, 96 | 96 |
| Parity | None, Odd, Even | None |
| Data Bits | 7, 8 | 8 |
| Stop Bits | 1, 2 | 1 |
| Mode | Talk, Talk/Listen | Talk/Listen |
| State | Disable, Enable | Disable |

Navigation arrows (up and down) are visible on the right side of the menu. A button at the bottom reads 'HIT MENU TO RETURN TO MAIN MENU'.

Figure 2-22
RS-232 Setup Format

Allows user setup of standard RS-232 interface formats. Choices include:

- Baud Rate** - 12, 24, 48 or 96 (for 1200, 2400, 4800, and 9600 respectively)
- Parity** - None, Even or Odd
- Data Bits** - 7 or 8
- Stop Bits** - 1 or 2
- Mode** - Talk or Talk/Listen

UP/DOWN arrow and **Enter** selects the desired format and then **LEFT/RIGHT** arrow and **ENTER** allows for selection of choices within each format.

2.6.3.7 IEEE-488.2 Interface

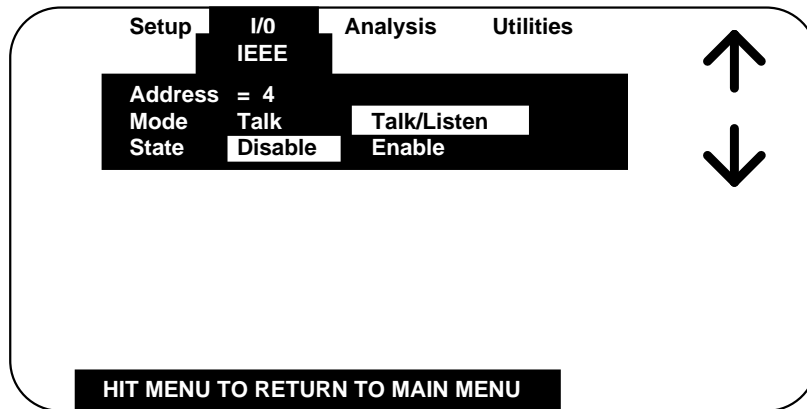

Figure 2-23
IEEE Setup Format

Allows user setup of IEEE-488 interface format. Choices include:

- Address** - 1 through 16
- Mode** - Talk or Talk/Listen
- State** - Disable or Enable

UP/DOWN arrow and **ENTER** selects the desired format and then **LEFT/RIGHT** arrow and **ENTER** allows for selection of choices within each format.

The instrument will function as either a Talk or a Talk/Listen device in a system depending on the choice made by the operator under Mode. Talk is generally suited to a simple system with no controller or other talkers, for example a printer. Talk/Listen denotes full programmability and is suited for use in a system that has a controller or computer to manage data flow. The "handshake" routine assures that the active talker proceeds slowly enough for the slowest listener.

2.6.3.8 Print Results

Allows user to output results to the parallel port by selection of **Off** or **On**.

CAUTION

Before selecting On make sure the printer is connected and on-line.

File format for printing is the same as shown in the next paragraph under **Results to Floppy**. Lines not printed are indicated.

2.6.3.9 Results to Floppy

Allows user to store measurement results on floppy disk (unless drive is not present). When selected, if a results file is not open, the user is prompted for the filename (up to 8 characters) and the file is opened.

To close a results file that is currently open, select Results to Floppy and close.

If a results file is open when a setup is saved, when the setup is later recalled the user will be prompted for a results file name.

When multiple tests are being conducted the results are stored to floppy periodically (every 10 measurements) from an internal buffer. **To be sure of storing all results before power is shut down the file needs to be closed** as discussed earlier. It is also important to note that a file should be closed before changing or recalling a new set of test conditions, otherwise the stored measurement results would not be consistent with the setup conditions stored in the file.

NOTE:

3 1/2" floppy disks must be formatted for **DOS compatibility** on a PC or purchased formatted from the manufacturer, 1.44M High Density or 720K Low Density. The floppy drive **does not support subdirectories**.

The measurement results are stored as a DOS text file under its assigned identifying number (up to 8 characters) with an extension of .b6r. The test setup conditions are saved as a header at the beginning of a results file. A sample file format is shown below. Note that the results can be stored in either engineering or scientific terms dependent on what the user has selected for setup conditions. The format of the result string is as follows:

```
Label<TAB>Primary result<TAB>Units<TAB>Label<TAB>Secondary  
result<TAB>Units<TAB>Bin#<CR><LF>
```

Sample file format as follows. Lines listed as **not printed** are not saved as results to floppy but only as Save Setup, refer to paragraph 2.6.5.1.

```

Copyright QuadTech Inc. 1997                not printed
ENDHEADER                                   not printed
2000000.000000    ;frequency
5.000000          ;primary parameter
2.000000          ;secondary parameter
0.000000          ;ac signal type
0.100000          ;ac signal value
0.000000          ;bias
0.000000          ;range
1.000000          ;rangelocked
68.000000         ;range relay                not printed
205.000000        ;relay 2                   |
69.000000         ;relay 3                   |
66.000000         ;va                        not printed
2.000000          ;measurment speed
0.000000          ;delay time
1.000000          ;# to average
0.000000          ;contact check
0.000000          ;display type
0.000000000009989577000    ;nominal value
0.000000          ;result format
1.000000          ;trigger
1.000000          ;handler
3.000000          ;baud
0.000000          ;parity
1.000000          ;data bits
0.000000          ;stop bits
1.000000          ;rs232 mode
1.000000          ;rs232 state
4.000000          ;IEEE address
1.000000          ;IEEE mode
0.000000          ;IEEE state
0.000000          ;print results
0.000000          ;result to floppy
0.000000000000000000000000    ;low limit bin 0                not printed
0.000000000000000000000000    ;high limit bin 0        |
0.000000000000000000000000    ;nominal value bin 0    |
0.000000          ;limit format bin 0        |
0.000000000000000000000000    ;low limit bin 1        |
0.000000000000000000000000    ;high limit bin 1      |
0.000000000000000000000000    ;nominal value bin 1    |
0.000000          ;limit format bin 1        |
0.000000000000000000000000    ;low limit bin 2        |
0.000000000000000000000000    ;high limit bin 2      |
0.000000000000000000000000    ;nominal value bin 2    |

```

| | | |
|------------------------|-----------------------|-------------|
| 0.000000 | ;limit format bin 2 | |
| 0.00000000000000000000 | ;low limit bin 3 | |
| 0.00000000000000000000 | ;high limit bin 3 | |
| 0.00000000000000000000 | ;nominal value bin 3 | |
| 0.000000 | ;limit format bin 3 | |
| 0.00000000000000000000 | ;low limit bin 4 | |
| 0.00000000000000000000 | ;high limit bin 4 | |
| 0.00000000000000000000 | ;nominal value bin 4 | |
| 0.000000 | ;limit format bin 4 | |
| 0.00000000000000000000 | ;low limit bin 5 | |
| 0.00000000000000000000 | ;high limit bin 5 | |
| 0.00000000000000000000 | ;nominal value bin 5 | |
| 0.000000 | ;limit format bin 5 | |
| 0.00000000000000000000 | ;low limit bin 6 | |
| 0.00000000000000000000 | ;high limit bin 6 | |
| 0.00000000000000000000 | ;nominal value bin 6 | |
| 0.000000 | ;limit format bin 6 | |
| 0.00000000000000000000 | ;low limit bin 7 | |
| 0.00000000000000000000 | ;high limit bin 7 | |
| 0.00000000000000000000 | ;nominal value bin 7 | |
| 0.000000 | ;limit format bin 7 | |
| 0.00000000000000000000 | ;low limit bin 8 | |
| 0.00000000000000000000 | ;high limit bin 8 | |
| 0.00000000000000000000 | ;nominal value bin 8 | |
| 0.000000 | ;limit format bin 8 | |
| 0.00000000000000000000 | ;low limit bin 9 | |
| 0.00000000000000000000 | ;high limit bin 9 | |
| 0.00000000000000000000 | ;nominal value bin 9 | |
| 0.000000 | ;limit format bin 9 | |
| 0.00000000000000000000 | ;low limit bin 10 | |
| 0.00000000000000000000 | ;high limit bin 10 | |
| 0.00000000000000000000 | ;nominal value bin 10 | |
| 0.000000 | ;limit format bin 10 | |
| 0.00000000000000000000 | ;low limit bin 11 | |
| 0.00000000000000000000 | ;high limit bin 11 | |
| 0.00000000000000000000 | ;nominal value bin 11 | |
| 0.000000 | ;limit format bin 11 | |
| 0.00000000000000000000 | ;low limit bin 12 | |
| 0.00000000000000000000 | ;high limit bin 12 | |
| 0.00000000000000000000 | ;nominal value bin 12 | |
| 0.000000 | ;limit format bin 12 | |
| 0.00000000000000000000 | ;low limit bin 13 | |
| 0.00000000000000000000 | ;high limit bin 13 | |
| 0.00000000000000000000 | ;nominal value bin 13 | |
| 0.000000 | ;limit format bin 13 | |
| 0.00000000000000000000 | ;low limit bin 14 | |
| 0.00000000000000000000 | ;high limit bin 14 | |
| 0.00000000000000000000 | ;nominal value bin 14 | |
| 0.000000 | ;limit format bin 14 | not printed |

| | | | |
|-------------|---------------------------|----------------------------------|--|
| 0.000000 | ;secondary low | | |
| 0.000000 | ;secondary high | | |
| 0.000000 | ;sequence | | |
| 0.000000 | ;sequence status | printed only if sequence enabled | |
| 1000.000000 | ;sequence frequency | | |
| 0.000000 | ;sequence pri param | | |
| 0.000000 | ;sequence sec param | | |
| 0.000000 | ;sequence bias | | |
| 0.000000 | ;sequence ac signal type | | |
| 1.000000 | ;sequence ac signal value | | |
| 0.000000 | ;sequence delay | | |
| 0.000000 | ;sequence range | | |
| 0.000000 | ;sequence range relay | | |
| 0.000000 | ;sequence relay 2 | | |
| 0.000000 | ;sequence relay 3 | | |
| 0.000000 | ;sequence var relay | | |
| 1.000000 | ;sequence stop on fail | | |
| 0.000000 | ;sequence status | | |
| 1000.000000 | ;sequence frequency | | |
| 0.000000 | ;sequence pri param | | |
| 0.000000 | ;sequence sec param | | |
| 0.000000 | ;sequence bias | | |
| 0.000000 | ;sequence ac signal type | | |
| 1.000000 | ;sequence ac signal value | | |
| 0.000000 | ;sequence delay | | |
| 0.000000 | ;sequence range | | |
| 0.000000 | ;sequence range relay | | |
| 0.000000 | ;sequence relay 2 | | |
| 0.000000 | ;sequence relay 3 | | |
| 0.000000 | ;sequence var relay | | |
| 1.000000 | ;sequence stop on fail | | |
| 0.000000 | ;sequence status | | |
| 1000.000000 | ;sequence frequency | | |
| 0.000000 | ;sequence pri param | | |
| 0.000000 | ;sequence sec param | | |
| 0.000000 | ;sequence bias | | |
| 0.000000 | ;sequence ac signal type | | |
| 1.000000 | ;sequence ac signal value | | |
| 0.000000 | ;sequence delay | | |
| 0.000000 | ;sequence range | | |
| 0.000000 | ;sequence range relay | | |
| 0.000000 | ;sequence relay 2 | | |
| 0.000000 | ;sequence relay 3 | | |
| 0.000000 | ;sequence var relay | | |
| 1.000000 | ;sequence stop on fail | | |
| 0.000000 | ;sequence status | | |
| 1000.000000 | ;sequence frequency | | |
| 0.000000 | ;sequence pri param | | |
| 0.000000 | ;sequence sec param | | |

| | | | |
|-------------|-------------------------------|--|--|
| 0.000000 | ;sequence bias | | |
| 0.000000 | ;sequence ac signal type | | |
| 1.000000 | ;sequence ac signal value | | |
| 0.000000 | ;sequence delay | | |
| 0.000000 | ;sequence range | | |
| 0.000000 | ;sequence range relay | | |
| 0.000000 | ;sequence relay 2 | | |
| 0.000000 | ;sequence relay 3 | | |
| 0.000000 | ;sequence var relay | | |
| 1.000000 | ;sequence stop on fail | | |
| 0.000000 | ;sequence status | | |
| 1000.000000 | ;sequence frequency | | |
| 0.000000 | ;sequence pri param | | |
| 0.000000 | ;sequence sec param | | |
| 0.000000 | ;sequence bias | | |
| 0.000000 | ;sequence ac signal type | | |
| 1.000000 | ;sequence ac signal value | | |
| 0.000000 | ;sequence delay | | |
| 0.000000 | ;sequence range | | |
| 0.000000 | ;sequence range relay | | |
| 0.000000 | ;sequence relay 2 | | |
| 0.000000 | ;sequence relay 3 | | |
| 0.000000 | ;sequence var relay | | |
| 1.000000 | ;sequence stop on fail | | |
| 0.000000 | ;sequence status | | |
| 1000.000000 | ;sequence frequency | | |
| 0.000000 | ;sequence pri param | | |
| 0.000000 | ;sequence sec param | | |
| 0.000000 | ;sequence bias | | |
| 0.000000 | ;sequence ac signal type | | |
| 1.000000 | ;sequence ac signal value | | |
| 0.000000 | ;sequence delay | | |
| 0.000000 | ;sequence range | | |
| 0.000000 | ;sequence range relay | | |
| 0.000000 | ;sequence relay 2 | | |
| 0.000000 | ;sequence relay 3 | | |
| 0.000000 | ;sequence var relay | | |
| 1.000000 | ;sequence stop on fail | | |
| 0.000000 | ;sweep | | |
| 0.000000 | ;sweep parameter | | |
| 10.000000 | ;sweep begin | | |
| 1000.000000 | ;sweep end | | |
| 0.000000 | ;sweep step | | |
| 0.000000 | ;sweep result format | | |
| 0.000000 | ;median | | |
| 1.000000 | ;correction | | |
| 25.000000 | ;correction primary nominal | | |
| 50.000000 | ;correction secondary nominal | | |
| 1.000000 | ;correction status | | |

printed only if sequence enabled

```

1000.000000 ;correction frequency
49.000000 ;correction range
5.000000 ;correction primary parameter
4.000000 ;correction secondary parameter
25.17072 ohms ;correction measured primary
-.1947500 ;correction measured secondary
-0.170725 ;correction primary correction
50.194742 ;correction secondary correction
0.000000 ;enhanced distortion
0.000000 ;lockout
1.000000 ;backlite

```

ENDHEADER

```

Cs    9.69573e-09 F    DF    0.0052921  Bin    1
Cs    9.69645e-09 F    DF    0.0052307  Bin    1
Cs    9.69575e-09 F    DF    0.0052404  Bin    1
Cs    9.69583e-09 F    DF    0.0052983  Bin    1
Cs    9.69698e-09 F    DF    0.0053328  Bin    1

```

The number of measurement results that can be stored is dependent on available disk space and length of the data string. For example; if no limit is set the measurement string contains no bin results, thus the string is fewer characters. The same is true with header information, multiple headers (different test conditions) will consume more memory. Whatever the case, a blank disk is capable of storing thousands of measurements.

2.6.4 Analysis Menu

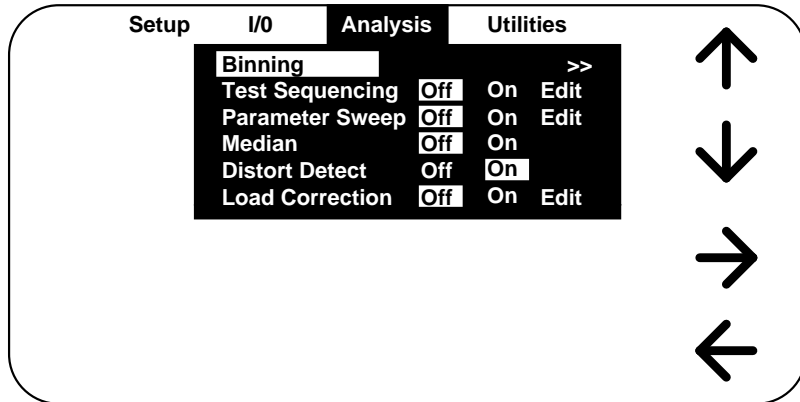
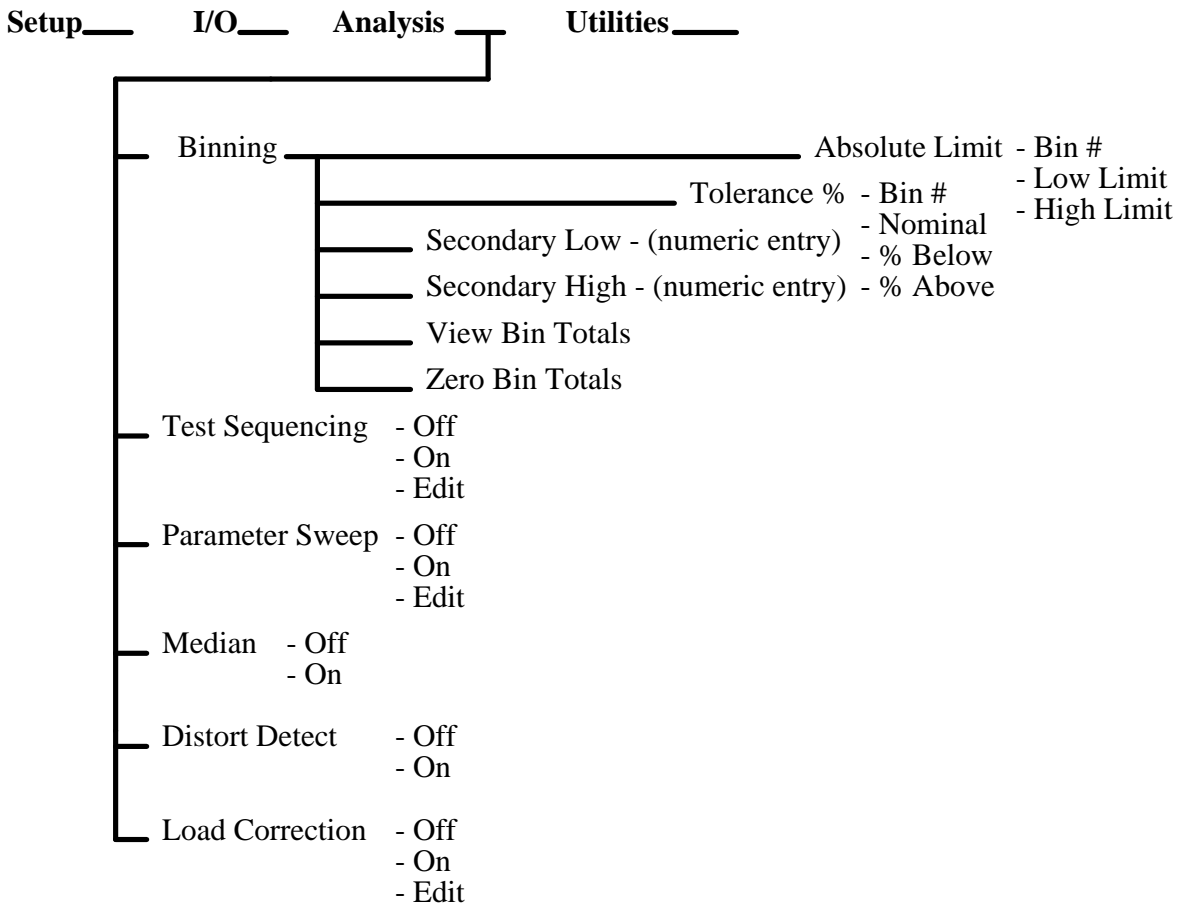

Figure 2-24
Analysis Menu

The third of the four main menus is **Analysis**, shown above. Each function controls the analysis of measurement results and is described in detail below.



2.6.4.1 Binning

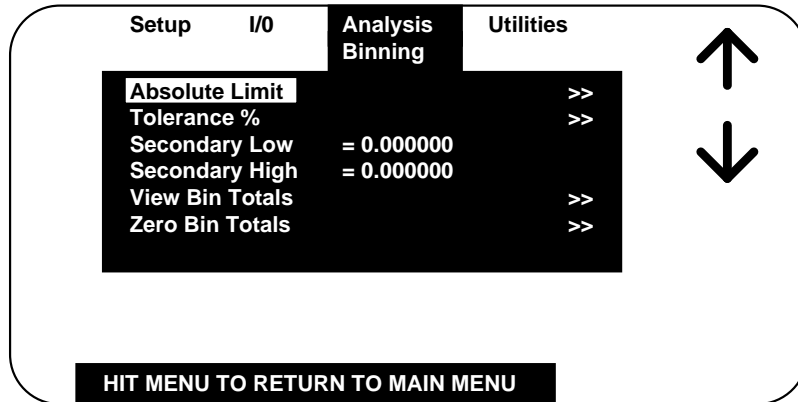

Figure 2-25
Binning

The 7600 provides sorting capability into **15 bins** (10 pass, 4 fail and 1 for no contact). For the binning function to be enabled, one or both of the two conditions must be met:

1. Bin 1 limits must be set (non-zero).
2. Secondary parameter must be set (not NONE, Figure 2-9) and secondary low/high limits must be set (non-zero).

These are assigned as follows:

- Bins 1 through 10 - **Pass** bins for the primary parameter (**Pass** for secondary parameter if limit is entered)
- Bin 11 - Primary parameter **pass** and secondary parameter **fail low**
- Bin 12 - Primary parameter **pass** and secondary parameter **fail high**
- Bin 13 - Primary parameter **fail** and secondary parameter **pass**
- Bin 14 - Primary parameter **fail** and secondary parameter **fail**
- Bin 15 - **No contact**

Note:

If no limit is entered for primary parameter but one is for the secondary parameter, bin assignment will be to Bin 1 for a **pass** and Bin 11 for a **fail low** or Bin 12 for a **fail high**.

Bin assignment during the test sequencing mode of operation is entirely different and discussed in paragraph 2.6.4.2.

Bin limits for the primary parameter can be entered in terms of absolute value or as a percent tolerance about a defined nominal. Two of the most common methods sorting is **nested** limits and **sequential** limits. Nested limits are a natural choice for sorting by % tolerance around a single nominal value with the lower number bins narrower than the higher numbered ones. Nested limits for three bins is illustrated below, note that limits do not have to be symmetrical as shown for bin 3.

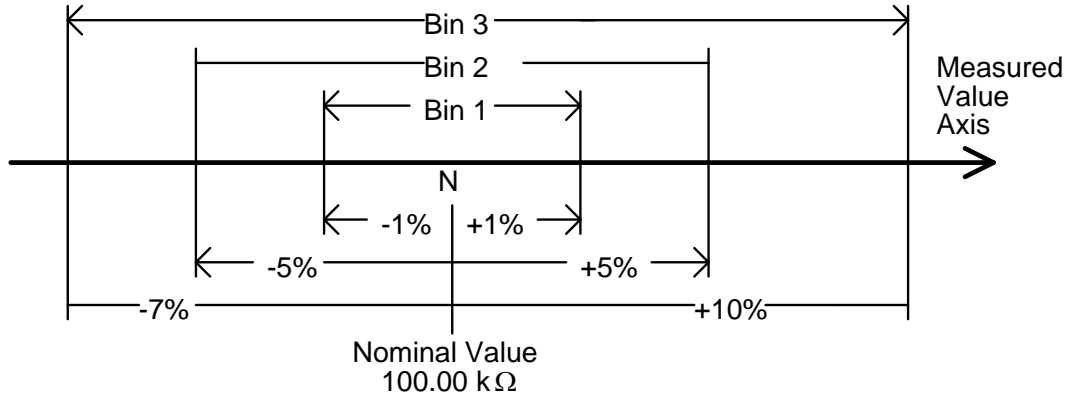

Tolerance Percent

| Bin | Nominal | % BELOW | % ABOVE |
|-----|----------|---------|---------|
| 1 | 100.00 k | 1.00 | 1.00 |
| 2 | 100.00 k | 5.00 | 5.00 |
| 3 | 100.00 k | 7.00 | 10.00 |

Sequential limits are a natural choice for sorting by absolute value. Sequential limits for three bins are illustrated below. It should be noted that the bins do not necessarily have to be adjacent. Depending on the specified limits for each they can be overlapping, adjacent or even isolated (gaps) from each other. Any overlap is assigned to the lower numbered bin and a gap would be assigned to the overall fail bin.

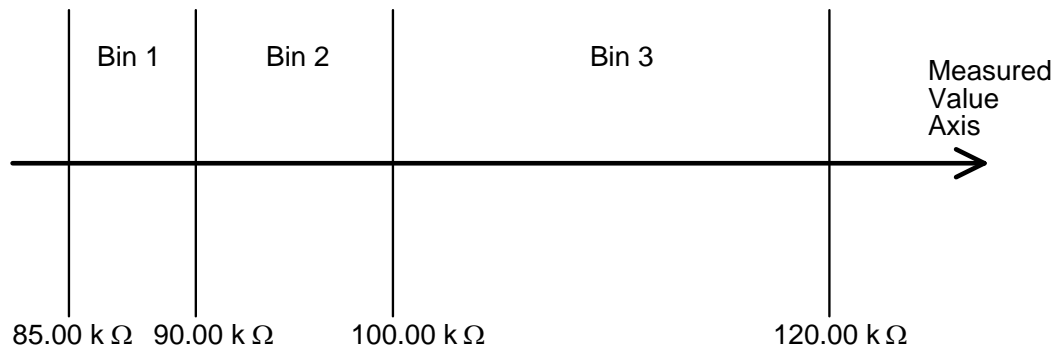

Absolute Limit

| Bin | Low LIMIT | High LIMIT |
|-----|-----------|------------|
| 1 | 85.00 k | 90.00 k |
| 2 | 90.00 k | 100.00 k |
| 3 | 100.00 k | 120.00 k |

- **Absolute Limit**

Absolute limit selection allows for entry of both **upper and lower limit for each bin in absolute value**. **Valid range for each is -10^8 to 10^9** . If zero is entered for Low or High, the previous value is cleared and that bin disabled. When limits are entered in terms of absolute value the same limits will automatically be shown in terms of percent on the Tolerance Percent Display. This automatic calculation should be used cautiously, imprecise displays and missed bin assignments are possible at the range extremes. Arrow up, down, left to right to select the limit of interest in either the low or high limit column as shown below (low limit for bin 5 is chosen in this example)

| Absolute Limit | | |
|----------------|-----------|------------|
| Bin | Low LIMIT | High LIMIT |
| 1 | 90.00 k | 110.00 k |
| 2 | 100.00 k | 120.00 k |
| 3 | 110.00 k | 130.00 k |
| 4 | 120.00 k | 140.00 k |
| 5 | 130.00 k | 150.00 k |
| 6 | 140.00 k | 160.00 k |
| 7 | 150.00 k | 170.00 k |
| 8 | 160.00 k | 180.00 k |
| 9 | 170.00 k | 190.00 k |
| 10 | 180.00 k | 120.00 k |

**Figure 2-26
Absolute Limit**

Once the limit of choice is selected by **UP/DOWN, LEFT/RIGHT** arrow and **ENTER** the numerical value can be entered directly as shown below (entry is 130 in this example).

| Absolute Limit | | |
|----------------|-----------|------------|
| Bin | Low LIMIT | High LIMIT |
| 1 | 90.00 k | 110.00 k |
| 2 | 100.00 k | 120.00 k |
| 3 | 110.00 k | 130.00 k |
| 4 | 120.00 k | 140.00 k |
| 5 | 130 | 150.00 k |
| 6 | 140.00 k | 160.00 k |
| 7 | 150.00 k | 170.00 k |
| 8 | 160.00 k | 180.00 k |
| 9 | 170.00 k | 190.00 k |
| 10 | 180.00 k | 200.00 k |

**Figure 2-27
Absolute Limit (Numeric Entry)**

Then arrow up or down to select units from those available (**k** is chosen in this example).

| Absolute Limit | | | ↑ ↓ |
|----------------|--------------|------------|--------|
| Bin | Low LIMIT | High LIMIT | |
| 1 | 90.00 k | 110.00 k | |
| 2 | 100.00 k | 120.00 k | |
| 3 | 110.00 k | 130.00 k | |
| 4 | 120.00 k | 140.00 k | |
| 5 | 130 k | 150.00 k | |
| 6 | 140.00 k | 160.00 k | |
| 7 | 150.00 k | 170.00 k | |
| 8 | 160.00 k | 180.00 k | |
| 9 | 170.00 k | 190.00 k | |
| 10 | 180.00 k | 120.00 k | |

Figure 2-28
Absolute Limit (Engineering Units)

Press ENTER to finalize the entry, the UP/DOWN, LEFT/RIGHT arrow to choose the next limit to be entered or changed.

- Tolerance Percent**

Tolerance Percent selection allows for entry of both **upper and lower limit in terms of percent below or above an entered nominal (both must be entered)**. When limits are entered in terms of percent the same limits will automatically be shown in terms of absolute value on the Absolute Value Display. Arrow up, down, left to right to select the nominal value or % limit of interest as shown below. The nominal value can be entered in the same fashion as the absolute limit is entered above, numerical value, then arrow Up or Down to select units. **Valid range is -10⁸ to 10⁹**. If zero is entered for Nominal, the entire row is cleared and that bin disabled. The % tolerance can be entered directly in increments of .01%, any increments smaller than this are rounded to the closest .01%. **Valid range for each is 0 to 100**. If zero is entered for %Below or %Above, the previous value is cleared and that bin disabled.

| Tolerance Percent | | | | ↑ ↓ → ← |
|-------------------|-----------------|---------|---------|------------------|
| Bin | Nominal | % BELOW | % ABOVE | |
| 1 | 100.00 k | 10.00 | 10.00 | |
| 2 | 110.00 k | 10.00 | 10.00 | |
| 3 | 120.00 k | 10.00 | 10.00 | |
| 4 | 130.00 k | 10.00 | 10.00 | |
| 5 | 140.00 k | 10.00 | 10.00 | |
| 6 | 150.00 k | 10.00 | 10.00 | |
| 7 | 160.00 k | 10.00 | 10.00 | |
| 8 | 170.00 k | 10.00 | 10.00 | |
| 9 | 180.00 k | 10.00 | 10.00 | |
| 10 | 190.00 k | 10.00 | 10.00 | |

Figure 2-29
Tolerance Percent

- **Secondary Low**

Accepts entry of numerical value for the low limit of the secondary parameter. Units are determined by the secondary parameter selection, i.e. in Farads, Ohms, Henries, etc. and selected by the UP/DOWN arrow keys. **Valid range is -10^3 to 10^4 .**

NOTE:
Low limit must be less than the High limit

- **Secondary High**

Accepts entry of numerical value for the high limit of the secondary parameter. Units are determined by the secondary parameter selection, i.e. in Farads, Ohms, Henries, etc. and selected by the UP/DOWN arrow keys. **Valid range is -10^3 to 10^4 .**

NOTE:
High limit must be greater than the Low limit

- **View Bin Totals**

| Bin | Low LIMIT | High LIMIT | Total |
|---------------------------------|-----------------------|------------|-------|
| 1 | 90.00 k | 110.00 k | 250 |
| 2 | 100.00 k | 120.00 k | 100 |
| 3 | 110.00 k | 130.00 k | 90 |
| 4 | 120.00 k | 140.00 k | 80 |
| 5 | 130.00 k | 150.00 k | 75 |
| 11 | PRI Pass SEC Fail LOW | | 60 |
| 12 | PRI Pass SEC Fail HI | | 55 |
| 13 | PRI Fail SEC Pass | | 50 |
| 14 | PRI Fail SEC Fail | | 20 |
| 15 | NO CONTACT | | 5 |
| Totals: | Pass 595 | Fail 190 | 785 |
| HIT MENU TO RETURN TO MAIN MENU | | | |

Figure 2-30
Bin Totals

The total count for each bin is tracked from 0 to 999,999.

- **Zero Bin Totals**

Bin count totals are all reset to zero when selected and returned to the Menu screen.

2.6.4.2 Test Sequencing

The 7600 is capable of performing a sequence measurement containing up to **six different test steps**. Different measurement parameters and conditions can be defined for each test in the sequence.

Test sequencing can be selected as **Off, On or Edit**. Edit allows measurement parameters and test conditions to be changed for all six tests. It is important to note that **tests can only be enabled in sequence**, for example, one can enable tests 1 through 3 but not tests 1 and 3 only, i.e. it is not possible to skip a test. For optimum measure speed performance, whenever possible, set test conditions of test 1 to be the same as default conditions, paragraph 2.5.2.

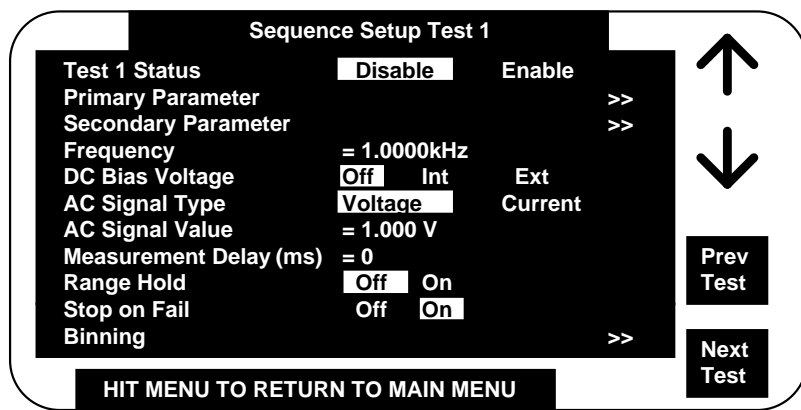

Figure 2-31
Sequence Setup (Test Conditions)

If Range Hold is turned ON and this is the "first" sequence measurement, for each test the 7600 automatically finds the correct range and completes a measurement (this range is saved for all future measurements) for that sequence only. It is important that the first part be "good" for the range hold to select the correct range. To repeat an auto range selection, turn sequences off and then back on again (making the next measurement taken the "first" sequence measurement).

Test conditions for each setup are selected as shown above except for the primary parameter, secondary parameter and binning, these are selected on individual menus as shown below. To change test conditions on any or all six tests select **Prev Test** or **Next Test** to access test conditions for that test.

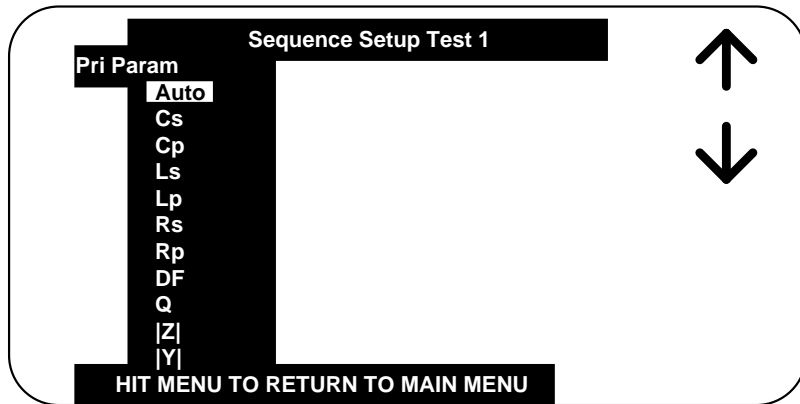

Figure 2-32
Sequence Setup (Parameter Selection)

Bin assignment in the test sequence mode is defined as follows:

| <u>Bin #</u> | <u>Assigned</u> |
|--------------|------------------------------------|
| Bin 1 | Test 1 (Primary parameter, fail) |
| Bin 2 | Test 1 (Secondary parameter, fail) |
| Bin 3 | Test 2 (Primary parameter, fail) |
| Bin 4 | Test 2 (Secondary parameter, fail) |
| Bin 5 | Test 3 (Primary parameter, fail) |
| Bin 6 | Test 3 (Secondary parameter, fail) |
| Bin 7 | Test 4 (Primary parameter, fail) |
| Bin 8 | Test 4 (Secondary parameter, fail) |
| Bin 9 | Test 5 (Primary parameter, fail) |
| Bin 10 | Test 5 (Secondary parameter, fail) |
| Bin 11 | Test 6 (Primary parameter, fail) |
| Bin 12 | Test 6 (Secondary parameter, fail) |
| Bin 13 | Unused |
| Bin 14 | Pass Bin |
| Bin 15 | Contact Check, fail |

For the binning function to be enabled, Bin 1 limits must be set (non-zero). If zero is entered for Low or High, the previous value is cleared and that bin disabled. **Valid range for primary or secondary is -10^8 to 10^9 .** All sequence binning limits must be entered on the display shown below and NOT the standard binning displays, paragraph 2.6.4.1.

| Sequence Setup Test 1 | | |
|-----------------------|-----------|------------|
| Bin | Low LIMIT | High LIMIT |
| 1 Pri | 90.00 k | 110.00 k |
| 2 Sec | 100.00 k | 120.00 k |

**Figure 2-33
Sequence Binning**

Test conditions of measurement sequences can be stored and/or recalled as part of test setups, refer to paragraphs 2.6.5.1 and 2.6.5.2 for storing or recalling setups. If a test sequence is **stored as On**, the sequence will be executed once the Start button is pressed, if the test sequence is **stored as Off**, the sequence will be inactive until turned on.

Note that a sequence (of up to six tests) can be terminated on any test of the sequence if the user has specified **Stop on Fail** for that test. If Stop on Fail is not selected the sequence continues until a failure occurs in a test where Stop on Fail has been enabled or until the whole sequence has been completed. Once a sequence is complete, it will be binned to the first fail bin (1 thru 12) or if all tests pass, binned into the overall pass bin (14).

When a test sequence is turned on the results of the sequence are shown on the summary screen shown below. Measured values outside of specified limits are highlighted.

| Sequence Results | | | |
|------------------|-----------------------|------------|-----------------------|
| FAIL | | BIN | 5 |
| Test 1 | Cs 1.561062 uF | DF | 0.0089290 |
| Test 2 | Cs 1.498650 uF | DF | 0.0078950 |
| Test 3 | Cs 1.278650 uF | DF | 0.0067994 FAIL |

**Figure 2-34
Sequence Results**

2.6.4.3 Parameter Sweep

The 7600 is capable of displaying a **table or plot of measured results vs. a variable of frequency, voltage or current.**

Sweep can be selected as **Off, On or Edit.** Edit allows sweep test conditions to be changed.

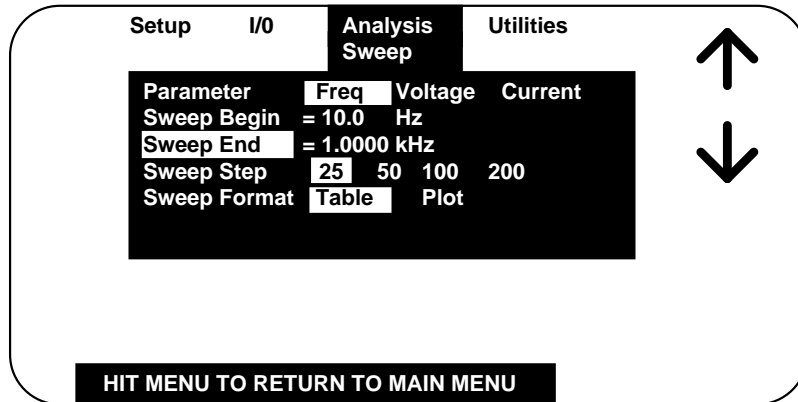

Figure 2-35
Parameter Sweep

Parameter is the variable test condition of **Frequency, Voltage or Current.**

Sweep Begin is the lower boundary of the sweep table or plot in **units of Hz, Volts or Amps.** The numerical value is entered directly and units selected by UP/DOWN arrow keys.

Sweep End is the upper boundary of the sweep in **units of Hz, Volts or Amps** and entered the same as Sweep Begin.

Sweep Step is the chosen number of increments in a sweep of **25, 50 100 or 200** where values are automatically selected, logarithmically over the specified begin to end range.

Sweep Format is selected to be **Table** as shown in Figure 2-36 or **Plot** as shown in Figure 2-37.

| Plot Table | | |
|------------|------------|----------|
| Frequency | Cs | DF |
| 1.0000kHz | 471.4576nF | 0.003135 |
| 1.2915kHz | 470.4563nF | 0.003675 |
| 1.6681kHz | 469.8878nF | 0.003867 |
| 2.1544kHz | 468.9983nF | 0.010035 |
| 2.7825kHz | 466.4532nF | 0.010078 |
| 3.5938kHz | 462.6634nF | 0.011045 |
| 4.6415kHz | 460.6645nF | 0.012895 |
| 5.9948kHz | 459.7892nF | 0.014786 |
| 7.7426kHz | 458.7845nF | 0.016782 |
| 10.000kHz | 456.5454nF | 0.018544 |

Figure 2-36: Sweep Table

The sweep table lists the measurement results for primary and secondary parameter (unless none is selected) along with the test condition variable of frequency, voltage or current. A table can be comprised of 25, 50, 100 or 200 entries and the UP/DOWN arrow keys or Prev or Next Page used to scroll through the display.

NOTE:
Scroll is not functional when RS-232 or IEEE-488 is enabled

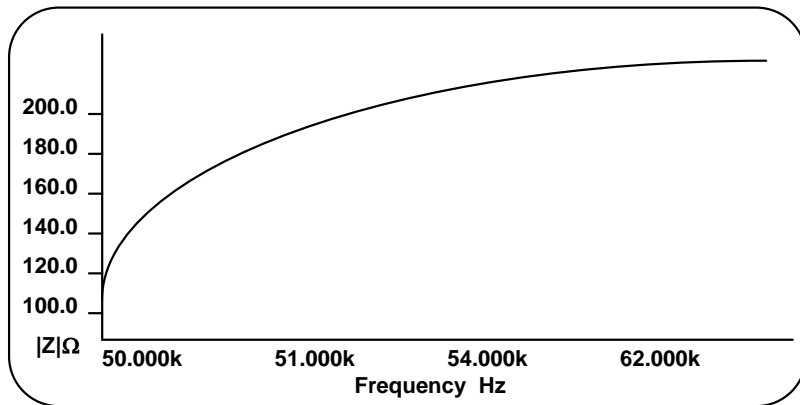

Figure 2-37: Sweep Plot

The sweep plot shows the measurement results of the primary parameter (vertical axis) vs. the variable test condition of frequency, voltage or current (horizontal axis). It should be noted that space available on the display **limits the number of graduations and resolution of axis labeling**. The horizontal axis is labeled from the **Sweep Begin to the Sweep End** values as selected by the user with two additional labels in between (chosen logarithmically). The vertical axis is labeled from the **lowest measured value to the highest measured value** with four additional labels in between (chosen linearly).

2.6.4.4 Median

Allows for the selection of Median measurement mode to be **On** or **Off**. When selected each measurement will actually be three individual measurements, the **lowest and highest values discarded and the median value displayed**.

Measurement accuracy can be improved as noted below and will be indicated on the AutoAcc display (but never less than 0.05% for primary parameter or 0.0005 for secondary parameter).

With Median set to **On**:

Divide the primary accuracy by the square root of three.

Divide the secondary accuracy by the square root of three.

2.6.4.5 Distortion Detection

Allows for the selection of Distortion Detection mode to be **On** or **Off**. When set to On, the unit will detect distortion during a measurement and indicates the message "DISTORTION" if this condition occurs. When set to Off, distortion will not be detected during a measurement.

Distortion is dependent on programmed test conditions, connection to the device, device impedance and so indicated when the signal + noise + distortion divided by the signal exceeds 1.2. Distortion set to On is the recommended test condition and is particularly important for high precision measurements where test leads could resonate with the device under test. Distortion may want to be turned to Off in a "noisy" environment.

To ensure that stored setups are backward compatible Distortion On or Off is not saved in setups stored (internally or on floppy). On instrument power down the Distort Detect will be restored to its last previous state.

2.6.4.6 Load Correction

Load correction allows the user to specify the value of the component under test (user supplied standard) and apply a correction to subsequent measurements of similar components under the same test conditions. This feature corrects for instrument non-linearity and for fixture effects which can be dependent on the test frequency, test voltage level or impedance range.

Measurement accuracy is 0.25 x (normal accuracy) with Load Correction implemented and compared to user supplied standard and for the same measurement conditions. Same measurement conditions being test voltage, test frequency and 7600 measurement range.

This increased accuracy applies in a range of:

DUT's with impedance (Z) between 3Ω and 800kΩ, with programmed voltage from 100mV to 1V, or from 100mV to (programmed current) x (Z) ≤1V.

Load correction can be selected as **Off, On or Edit**. Edit allows the primary and secondary values to be entered, the parameter for these values is defined by the Primary and Secondary Parameter in the main Setup menu. After the nominal values have been entered, if **Measure** is selected for **ON** the user presses **START** to initiate the correction measurement. While the measurement is being made, **Measuring Correction** will be displayed. After the correction measurement the actual **Measured Primary** and **Secondary** value will be displayed along with the selected **Freq, Range, Primary** and **Secondary** parameter. During the load correction measurement the instrument is automatically placed in the Slow Measurement Accuracy mode.

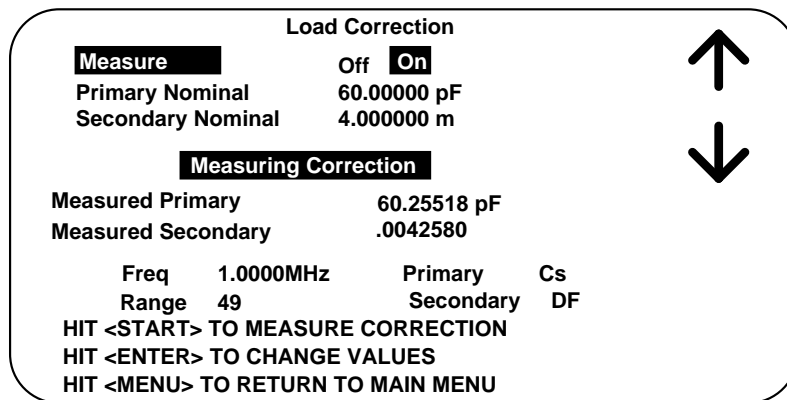

Figure 2-38
Load Correction

The Load Correction will only be made for the Frequency, Range, Primary and Secondary Parameter that was selected when the correction was determined. For example; if the correction measurement is made under the conditions of Cs, DF, at 1 MHz and range 49, these are the only conditions under which it will be applied.

2.6.5 Utilities Menu

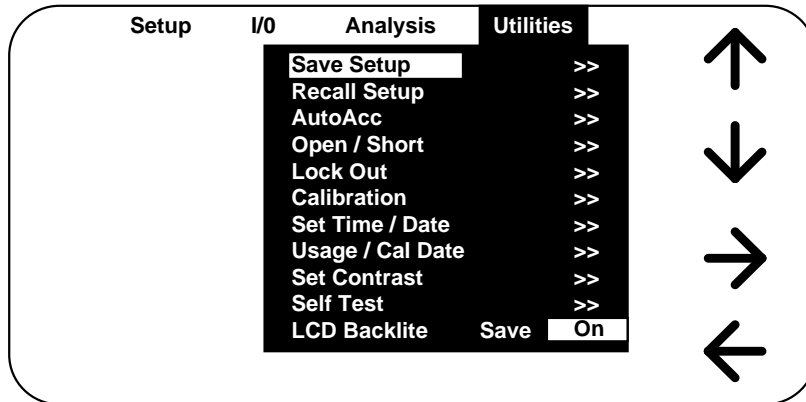
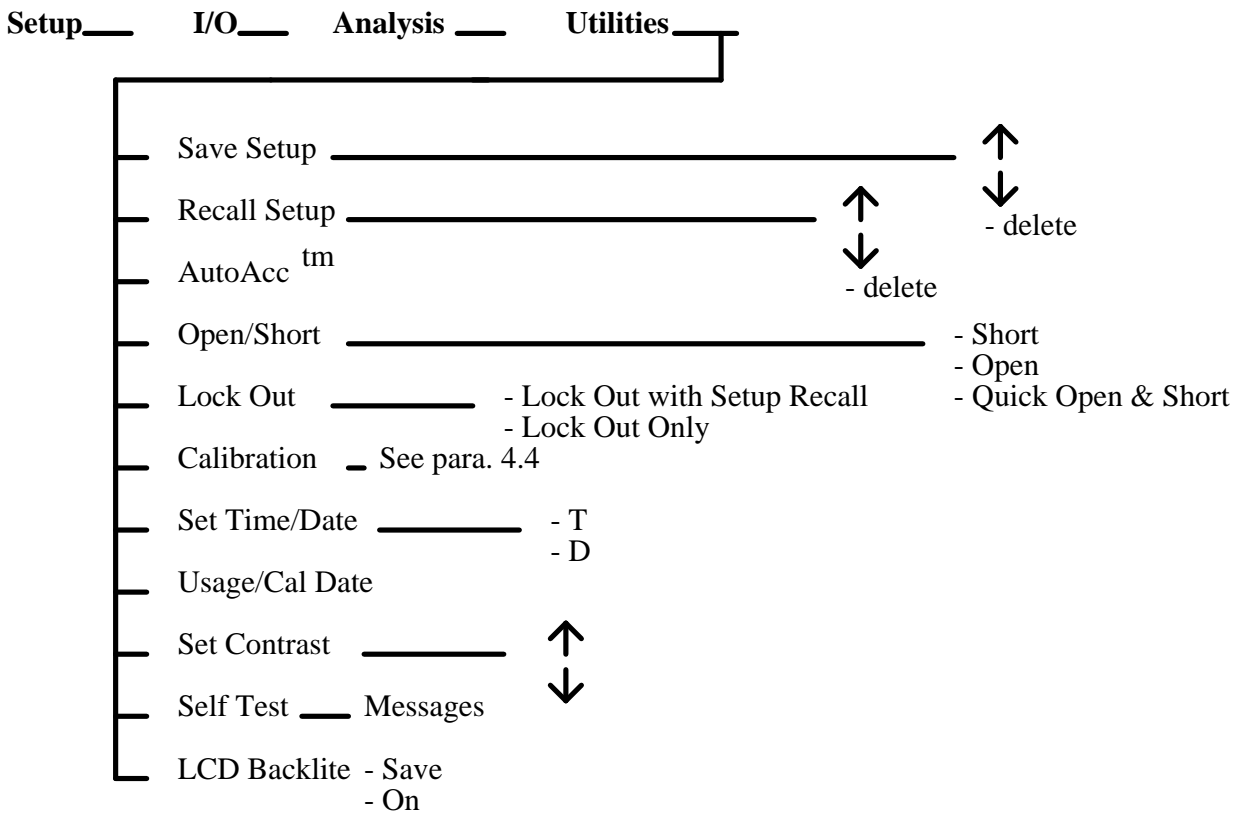

Figure 2-39
Utilities Menu

The last of the four main menus is **Utilities**, shown above. Each function is described in detail below.



2.6.5.1 Save Setup

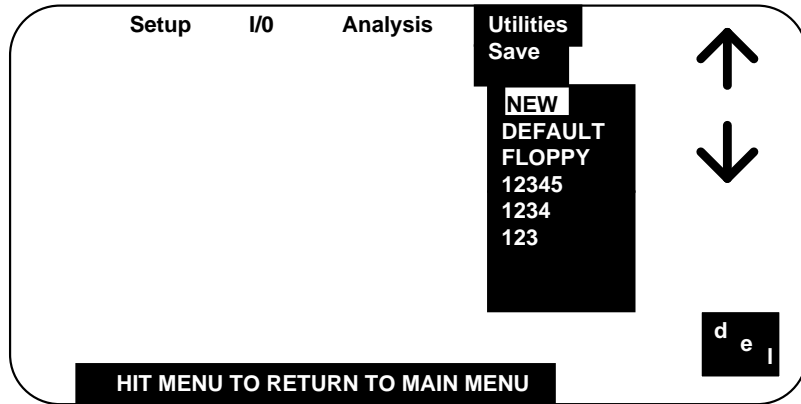

Figure 2-40
Save Setup

Allows a set of test conditions to be stored in instrument memory or on floppy disk for later recall. Test conditions are those that are user programmable in the Setup and I/O menus, as discussed in paragraphs 2.6.2 and 2.6.3. **Setups stored on non-Model B 7600's are not compatible with the 7600 Model B.**

Stored setup conditions should always be backed up on disk using the floppy drive. The number of setups saved to floppy is limited to 125.

To store the current set of test conditions as a new set in unit memory one needs to select **NEW** in the Save Setup menu and enter the identifying name up to 8 characters under which these conditions will be stored (allowable characters from the keypad include 0 through 9 and minus, characters can also include A through Z when operating from remote control). To save the setup under the name selected or to overwrite if the name already exists one needs to answer Yes or No, Figure 2-41.

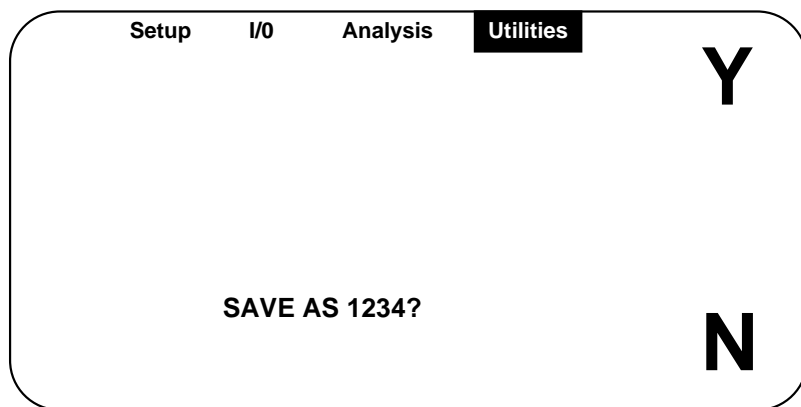

Figure 2-41
Yes or No

To make the current set of test conditions the default (at power up) one needs to select **DEFAULT** in the Save Setup menu and overwrite the conditions currently stored. To prevent overwriting the default setup by mistake an additional level of safety exists where the operator is required to respond with Yes or No, similar to Figure 2-41 above.

Selecting **del** will delete a set of test conditions and requires a Yes or No response.

When there are more setups than can fit on the display the page down key is active. If there is less than a whole page below, the display wraps around to the previous display. Continuing to page down will eventually return to the first display of setups. The page down key is only shown when there are more setups than what is visible.

There are two ways to make the current set of test conditions overwrite an existing setup, one is to select that setup in the menu and answer Yes to overwrite and the other way is to enter the same name under New and answer Yes to overwrite.

File format for storing test conditions is the same as shown under Results to Floppy, paragraph 2.6.3.9, all lines shown are saved as setup. The extension of files saved to floppy is .b6s.

2.6.5.2 Recall Setup

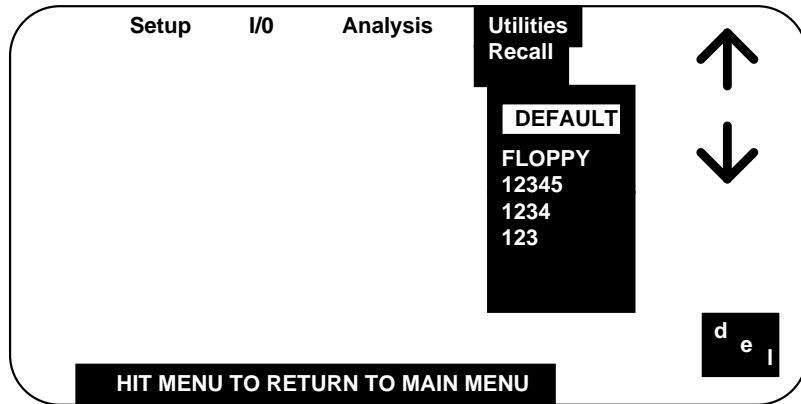

**Figure 2-42
Recall Setup**

Allows a previously stored set of test conditions to be recalled from instrument memory. Test conditions are those that are user programmable in the Setup and I/O menus as discussed in paragraphs 2.6.2 and 2.6.3. **Setups stored on non-Model B 7600's are not compatible with the 7600 Model B.** To recall a set of test conditions one needs to arrow down or up to the desired set. **DEFAULT** is always one of the set of test conditions that can be recalled as discussed in the previous paragraph. Selecting **FLOPPY** allows setups to be recalled from disk (unless drive is not present). Selecting **del** will delete a set of test conditions and requires a Yes or No response.

When there are more setups than can fit on the display the page down key is active. If there is less than a whole page below, the display wraps around to the previous display. Continuing to page down will eventually return to the first display of setups.

2.6.5.3 Setup Accuracy

Allows user to access the measurement calculation. Calculated accuracy is displayed for the instruments currently selected test conditions, as shown in the example below and **in accordance with the formulas for fast, medium or slow accuracy**. Factors affecting this calculation include frequency, ac test signal level, measurement accuracy and # to average, all test conditions under operator control on the Setup Menu. The selection of Median, on the Analysis Menu, also has an affect on the accuracy calculation.

The Accuracy, Average and Median can be changed on this screen as instructed for the purpose of evaluating their effect on the instrument accuracy calculation and the changes implemented if the operator so chooses. The frequency, AC signal or parameter selection can only be changed on the Setup menu. **In summary**, this display shows instrument **accuracy for currently selected test conditions** or as a tool so the operator can see **what the accuracy would be** if certain conditions were selected.

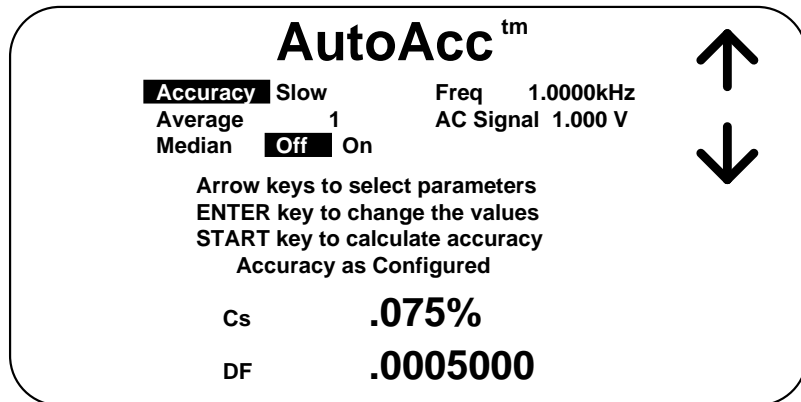

**Figure 2-43
Setup Accuracy**

The basis for the AutoAcc calculation is based on the formulas below where A% = calculated primary accuracy for C, X, B with $D < 0.1$ and R, L, G with $Q < 0.1$ for optimum signal levels and test conditions.

For C, X, and B, with $D > 0.1$, multiply A% by $\sqrt{1+D^2}$

For R and G, with $Q > 0.1$, multiply A% by $\sqrt{1+Q^2}$

For L, with $Q < 10$, multiply A% by $\sqrt{1+1/Q^2}$

Multipliers do not apply to 1 MHz Special Case Accuracy

For Fast Mode, R, L, C, X, G, B, |Z|, and |Y|

$$A\% = \pm \left[0.25 + \left(\left(0.25 + \frac{.125}{|Z_m|} + (|Z_m| * 10^{-6}) \right) * \left(\frac{0.2}{V_s} + 0.8 * \frac{V_{fs}}{V_s} + \frac{(V_s - 1)^2}{4} \right) * \left(0.4 + \frac{F_m}{10^4} + \frac{400}{F_m} \right) \right) \right] * K_t$$

For Medium Mode, R, L, C, X, G, B, |Z|, and |Y|

$$A\% = \pm \left[0.125 + \left(\left(0.125 + \frac{.05}{|Z_m|} + (|Z_m| * 10^{-6}) \right) * \left(\frac{0.2}{V_s} + 0.8 * \frac{V_{fs}}{V_s} + \frac{(V_s - 1)^2}{4} \right) * \left(0.4 + \frac{F_m}{3 * 10^4} + \frac{300}{F_m} \right) \right) \right] * K_t$$

For Slow Mode, R, L, C, X, G, B, |Z|, and |Y|

$$A\% = \pm \left[0.025 + \left(\left(0.025 + \frac{.05}{|Z_m|} + (|Z_m| * 10^{-7}) \right) * \left(\frac{0.2}{V_s} + 0.8 * \frac{V_{fs}}{V_s} + \frac{(V_s - 1)^2}{4} \right) * \left(0.7 + \frac{F_m}{10^5} + \frac{300}{F_m} \right) \right) \right] * K_t$$

V_s = Test voltage in voltage mode, $I * Z_m$ in current mode*

Z_m = Impedance of DUT F_m = Test frequency

K_t = 1 for 18^o to 28^oC, 2 for 8^o to 38^oC, and for 4 for 5^o to 45^oC

* For $I * Z_m > 3$, accuracy is not specified

V_{FS} = 5.0 for 1.000V < V_s ≤ 5.000V

1.0 for 0.100V < V_s ≤ 1.000V

0.1 for 0.020V ≤ V_s ≤ 0.100V

For $Z_m > 4 * Z_{RANGE}$ multiply A% by 2

For $Z_m > 16 * Z_{RANGE}$ multiply A% by 4

For $Z_m > 64 * Z_{RANGE}$ multiply A% by 8

In Voltage Mode

where 100kΩ for $Z_m \geq 25k\Omega$

Z_{RANGE} = 6kΩ for 1.6kΩ ≤ Z_m < 25kΩ

6kΩ for $Z_m > 25k\Omega$ and $F_m > 25kHz$

400Ω for 100Ω ≤ Z_m < 1.6kΩ

400Ω for $Z_m > 1.6k\Omega$ and $F_m > 250kHz$

25Ω for $Z_m < 100\Omega$

In Current Mode

400Ω for $i < 2.5mA$

25Ω for $i > 2.5mA$

NOTE: Calculated Rs accuracy applies only when device under test is primarily reactive

Calculated ESR accuracy applies only when device under test is primarily capacitive

The unit is unspecified for $F_m > 1.0$ MHz and $V_s > 0.5V$ and for $F_m > 500$ kHz and $V_s > 1.0V$

D Accuracy

$$= \left[\frac{A\%}{100} + \frac{|D|}{50} \right] * \left[1 + \sqrt{\frac{F_m}{5 * 10^4}} \right]$$

Q Accuracy

$$= \frac{A\%}{100} + \left[\frac{A\%}{100} + \frac{1}{50} \right] * |Q| + Q^2 \left[\frac{A_n}{100} + \frac{A\%}{500} \right]$$

θ Accuracy

$$= \frac{A\%}{20} * \left(\frac{180}{\pi} \right)$$

ESR Accuracy

$$= \left(\frac{A\%}{100} \right) * Z_m$$

D = DF of unknown Q = Q of unknown

A% = calculated primary accuracy for all cases

1 MHz Special Case Accuracy

(1 MHz, C = 100pF to 1000 pF, Z_m 158 to 1.6kΩ, D or Q < 0.01, voltage mode, V_s ≤ 1V)

Fast Mode Accuracy

$$A\% = \pm \left[\frac{A_n}{0.05} * \left(.067 * \left(1 + \frac{.2}{V_s} + \frac{V_s^2}{4} \right) \right) * \left(\frac{(2 * V_{FS} - V_s)}{V_{FS}} \right) + (A_n - .05) \right] * K_t$$

A_n = nominal accuracy 0.5.

Medium Mode Accuracy

$$A\% = \pm \left[\frac{A_n}{0.05} * \left(.067 * \left(0.8 + \frac{.2}{V_s} + \frac{V_s^2}{4} \right) \right) * \left(\frac{(2 * V_{FS} - V_s)}{V_{FS}} \right) + (A_n - .05) \right] * K_t$$

A_n = nominal accuracy 0.25.

Slow Mode Accuracy

$$A\% = \pm \left[\frac{A_n}{0.05} * \left(.067 * \left(0.55 + \frac{.2}{V_s} + \frac{V_s^2}{4} \right) \right) * \left(\frac{(2 * V_{FS} - V_s)}{V_{FS}} \right) + (A_n - .05) \right] * K_t$$

A_n = nominal accuracy 0.05.

NOTE:

Accuracy given by the equations is the measurement accuracy relative to calibration standards. Total accuracy equals the relative measurement accuracy plus the calibration uncertainty of the calibration standards.

2.6.5.4 Open / Short

The zeroing process automatically measures stray parameters and retains the data, which is used to correct measurements so that results represent parameters of the DUT alone without test lead or fixture capacitance. Measurement accuracy is specified at the end of the QuadTech one meter cable (7000-01). Open and short circuit zeroing should be done at the end of this cable. In order to maintain instrument accuracy with other cable lengths the instrument should be re calibrated using the QuadTech 7000-09 Calibration Kit and the alternate cable. Zeroing is recommended at the start of each work day or more often if leads, fixture or test configuration to the DUT is changed. **It is not necessary to re-zero if the test frequency is changed.** It is important to note, that anytime the instrument is zeroed it is done at a test voltage of 1 volt and frequencies of 10, 50, 100Hz, 1, 5, 10, 25, 50, 100, 250, 500, 750kHz, 1, 1.25, 1.5, 1.75 and 2MHz. Once Open/Short is selected in the menu and Enter key pressed the operator is prompted by instructions on the display for short or open zeroing as shown in Figure 2-43 below. When zeroing, **Contact Check should be OFF, # to Average to 1 and Median OFF.**

When the instrument measurement accuracy is selected for **SLOW** the unit will perform its Open/Short in this mode. When the instrument accuracy is selected for **MEDIUM** or **FAST** the unit will perform its Open/Short in the Medium mode. The Open/Short performed in the Slow mode is necessary only for measurements with extreme accuracy requirements at very high or low impedance. Open/Short takes about 5 minutes in the Medium mode versus about 15 minutes in the Slow mode.

When **Quick Open & Short** is selected the zeroing process is performed as prompted on the display, in much less time and **only at the frequency currently selected** on the instrument. It is important to note that the quick open and short data is no longer valid if frequency is changed, if sweep or sequence is selected or instrument powered down.

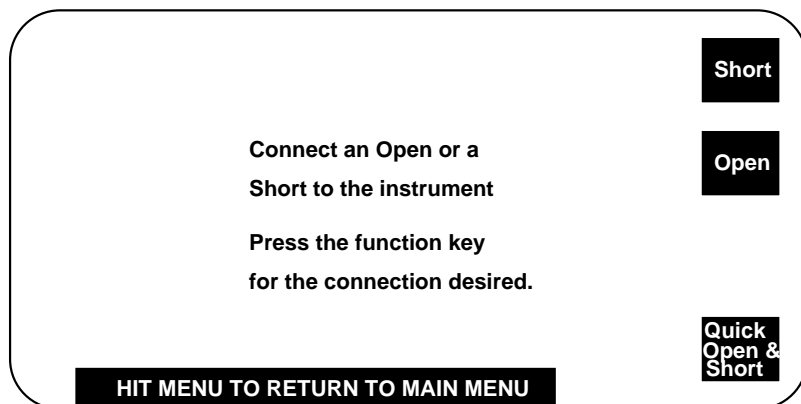

Figure 2-44
Open / Short

2.6.5.5 Lock Out

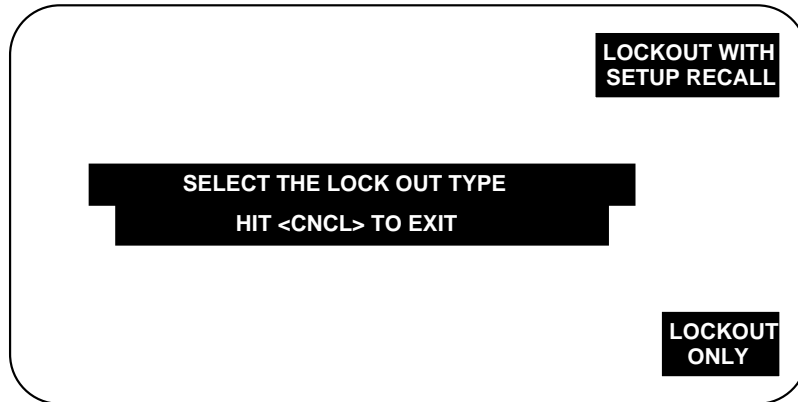

Figure 2-45
Lockout

Allows user to turn keypad lock feature on or off. There are two choices that can be selected, **lockout only** and **lockout with setup recall**. In both modes only the START, STOP and MENU on the instrument front panel are active, all other keys disabled. The difference is that in **lockout with setup recall** the menu key also allows setups to be recalled from instrument memory.

When either is selected the operator must enter a password number up to 8 characters.

CAUTION

FOR SECURITY REASONS THE PASSWORD IS NOT DISPLAYED WHEN IT IS ENTERED, SO THE PASSWORD SHOULD BE KEYED IN DISTINCTLY AND REMEMBERED. FAILURE TO REMEMBER AN ENTERED PASSWORD REQUIRES CALLING THE FACTORY FOR OVERRIDE INFORMATION.

ENTER PASSWORD
(8 CHARACTERS MAXIMUM)

* * * * *

Once the password is entered and entered again for verification, testing can begin by pressing START or the password cleared or changed by selecting MENU.

HIT <MENU> KEY TO ENTER PASSWORD
AND TO RETURN TO THE MENU
OR
HIT THE <START> KEY TO
START A MEASUREMENT

Once activated, only the START, STOP and MENU on the instrument front panel are active, all other keys are disabled. To turn the lockout feature off and reactivate menus select MENU (select Exit Lockout in Lockout with Setup Recall mode) and enter the previous password from the keypad, the instrument will again function as normal.

If Recall Setups is chosen in the Lockout with Setup Recall mode, the instrument functions as described in paragraph 2.6.5.2 under Recall Setup.

2.6.5.6 Calibration

Refer to Calibration in Paragraph 4.4. **INSTRUMENT CALIBRATION SHOULD ONLY BE PERFORMED BY QUALIFIED SERVICE PERSONNEL.**

2.6.5.7 Set Time/Date

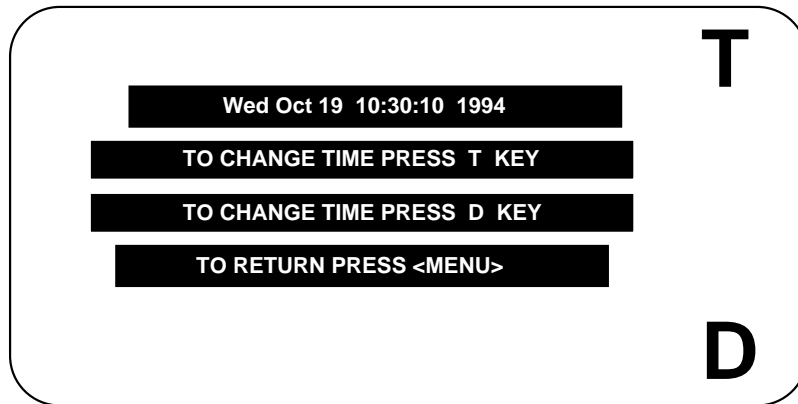

Figure 2-46
Set Time / Date

Allows resetting of time and date into unit memory. This is used as the basis for the elapsed time counter and stored calibration date.

T (time) is entered in

HOURS (up to 2 digits, 0 through 23)
MINUTES (up to 2 digits, 0 through 59)
SECONDS (up to 2 digits, 0 through 59)

D (date) is entered in

MONTHS (up to 2 digits, 1 through 12)
DAYS (up to 2 digits, 1 through 31)
YEARS (4 digits, 1992 through 2037)

2.6.5.8 Usage/Cal Date

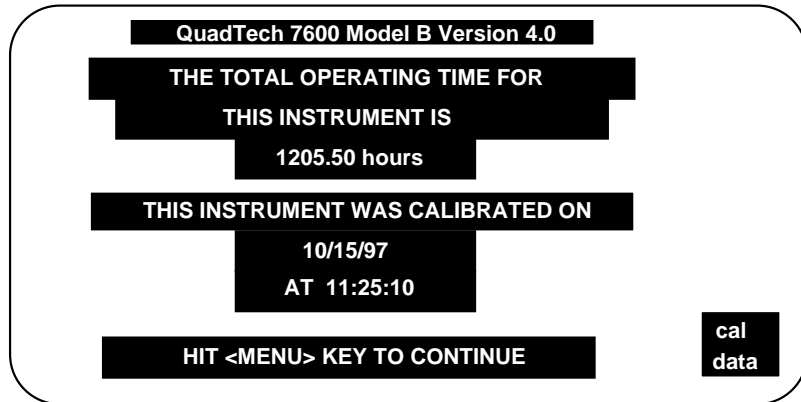

Figure 2-47
Usage / Cal Date

When selected, indicates the total elapsed time in hours that the unit has been powered up and the date of last calibration. The elapsed time is from the moment of initial use and may show some time when shipped from the factory. The calibration date is retained in instrument memory unit the unit is re calibrated and then it is updated. When **cal data** is selected, the calibrated values are shown as entered from the Report of Calibration provided with the 7000-09 Calibration Kit previously used. Refer to paragraph 4.4.

2.6.5.9 Set Contrast

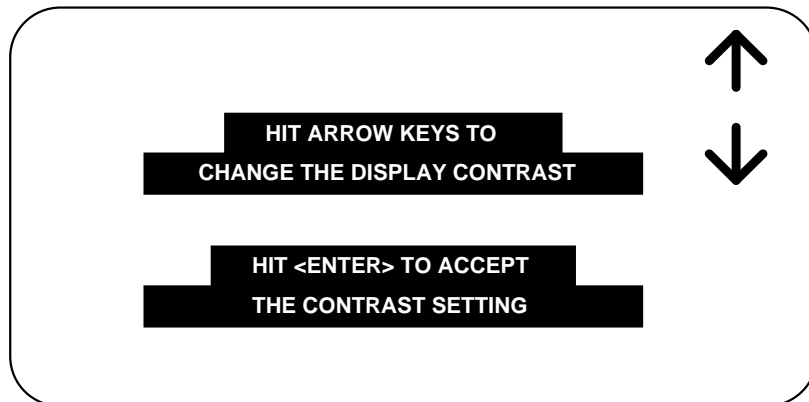

Figure 2-48
Set Contrast

Allows adjustment of contrast on the LCD display. Use Up arrow to increase contrast or Down arrow to decrease. When the instrument is powered up it returns to the last set contrast, not some nominal level.

2.6.5.10 Self Test

When selected, runs a group of internal self tests to verify that calibration and open/short data are not corrupt.

2.6.5.11 LCD Backlite

Allows the backlite on the LCD display to be **Save** or **On**. When set to **Save** the backlite turns off automatically if no keypad has been hit for 5 minutes and turns back on with the touch of **START**, **MENU** or **ENTER** keys. When set to **On** the backlite is constantly on. The **Save** mode will prolong the life of the display.

2.7 Input/Output Interface

2.7.1 I/O Interface

The 7600 comes standard with an automatic component handler I/O interface port available through a 36 pin Centronics type connector located on the rear panel of the instrument. This port outputs signals to indicate measurement in process, measurement completed, and bin sorting judgments. The Handler Interface also has inputs for an external trigger signal and a safety interlock signal. All output lines are negative true, optically isolated, open collector. Pull-up resistors to allow operation from +5V to +24V logic must be implemented externally. Inputs are optically isolated, and can be current driven from either positive or negative true logic. Current limiting resistors to allow operation from +5V to +24V logic must be implemented externally.

Refer to Table 2-1 for signal names, pin numbers and functions as necessary for cable connections.

Table 2-1
I/O Interface Connections

| Signal Name | Pin Number | Function |
|--------------------|-------------------|---|
| -Bin1 | 1 | Bin Sorting Results (Bin1-Bin10) |
| -Bin2 | 19 | All signals active low, open collector |
| -Bin3 | 2 | |
| -Bin4 | 20 | |
| -Bin5 | 3 | |
| -Bin6 | 21 | |
| -Bin7 | 4 | |
| -Bin8 | 22 | |
| -Bin9 | 6 | |
| -Bin10 | 24 | |
| -Bin11 | 7 | Primary parameter pass, secondary fail low |
| -Bin12 | 25 | Primary parameter pass, secondary fail high |
| -Bin13 | 8 | Primary parameter fail, secondary pass |
| -Bin14 | 26 | Primary parameter fail, secondary fail |
| -Bin15 | 9 | No Contact |
| -Bin16 | 27 | Unused |
| -EOT | 29 | End of Test, test completed and bin and measurement data valid. |

Table 2-1: I/O Interface Connections (continued)

| Signal Name | Pin Number | Function |
|--------------------|-------------------|---|
| -BUSY | 30 | Measurement/comparison in progress |
| TRIG+ | 14 | Trigger high input |
| TRIG- | 16 | Trigger low input |
| START+ | 34 | Isolated Trigger high input |
| START- | 35 | Isolated Trigger low input source |
| GND | 11, 15, 33 | System common |
| IGND | 5, 10, 23, 28 | Isolated common |
| +5V | 12, 32 | System +5V through 100 ohms |
| INT+ | 13 | Interlock high input from external source |
| HTC | 31 | Handler timing control |



Pin Configuration (Viewed from Rear Panel)

Operation

WARNING

Do not apply an external source in excess of 5 volts with jumpers JP2, JP3 or JP4 in place, otherwise the instrument can be damaged. The instrument is shipped with these jumpers in place and must be removed for optical isolation. These jumpers are discussed below and physically located on the I/O board, and depending on the I/O board version may be located under the stack.

The operation of START and TRIG circuits is identical. Both inputs are active low, for optical isolation they require a positive +5 to +24V external source and current limiting resistor to operate. START is always optically isolated. TRIG can be converted to a *isolated active low input* by removing jumper JP3 on the I/O PCB. Both signals are open collector OR'ed on the I/O pcb; current flowing through the isolator input on either signal causes a single Start line to be pulled low.

The INTerlock signal can be optically isolated, and also requires a positive +5 to +24V external source and current limiting resistor to operate. This signal can be converted to a *isolated active low input* by removing jumper JP4 on the I/O PCB. Current flowing through the isolator input causes the internal Interlock line to be driven low.

All bin and control outputs can be active low optically isolated open - collector drivers that pull each signal line to IGND (isolated common) when asserted. All outputs require

a positive +5 to +24V external source (referenced to IGND) and pull-up resistor to operate as fully isolated signals. IGND can be isolated from system GND by removing jumper JP2 on the I/O PCB. With jumper JP2 in place optical isolation is defeated allowing the outputs to be pulled up to the system +5V with external resistors.

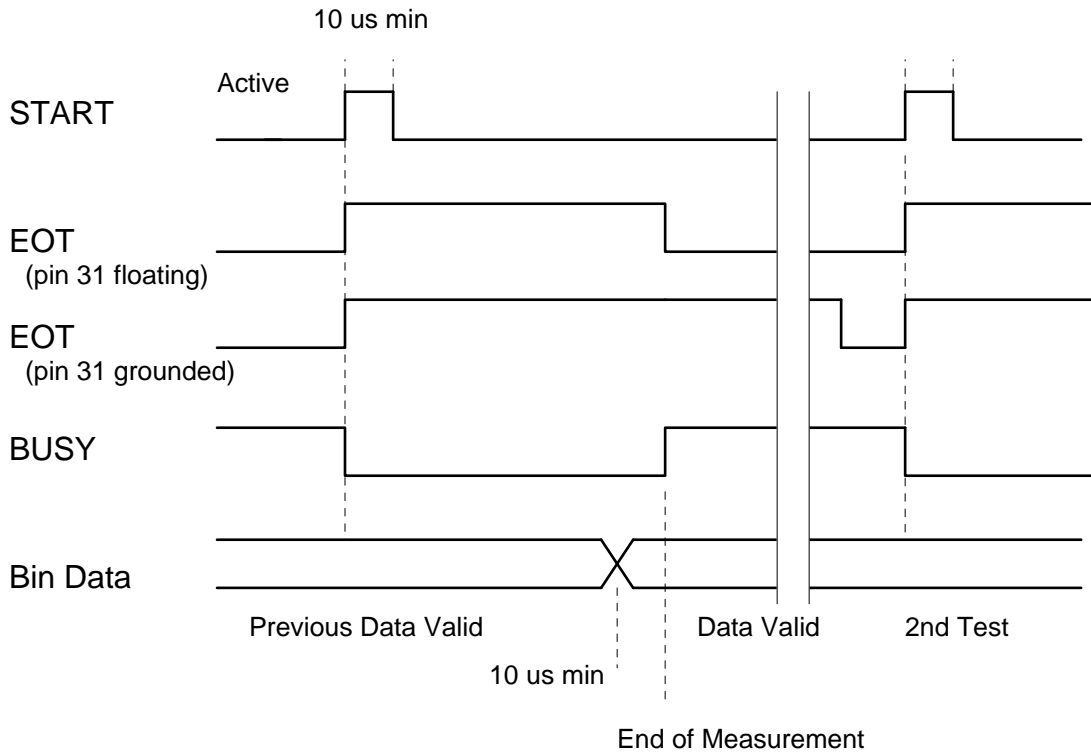

Figure 2-49
I/O Interface Timing

Test Initiation

- A test is initiated by activating either the START+/- or TRIG+/- inputs.
- The BUSY line is asserted low to indicate that a measurement is in progress.
- The EOT line is de-activated (asserted high) to indicate that the end of the test had not been reached
- Binning data from the previous test is still valid.

During a Test

- The START+/- or TRIG+/- inputs are released and return to their inactive state.

- The BUSY line is held low to indicate that the 7600 is making a measurement.
- The EOT line is held high (inactive) until the 7600 is done making a measurement and bin data is valid.

End of Test

- The BUSY line is returned to high impedance (de-activated) to indicate that the 7600 is done making a measurement. This condition may be used to signal the automatic component handler to advance the DUT to the binning station and insert the next DUT.
- Simultaneously, the EOT line is asserted low to indicate that the test is completed, bin data lines and measurement data are valid and can be read from the IEEE or RS-232 ports. Data must be valid a minimum of 10us before the trailing edge of BUSY and EOT.
- All data for the current test is valid, and will remain valid until the end of the next test. This includes comparator bins 1-10, primary and secondary parameter bins 11-15, and analog measurement data.

Electrical Characteristics

Inputs: START+/-, TRIG+/-

| <u>Condition</u> | <u>Input Current</u> | <u>Input Voltage</u> |
|---|----------------------|----------------------|
| Active High Signal+ current driven, Signal- @ IGND | 5 - 60 mA | 5 - 24V |
| Active Low Signal- current driven, Signal+ @ V+(ext) | 5 - 60 mA | 5 - 24V |

Outputs: -Bin1 : -Bin16, -EOT, -BUSY

| <u>Condition</u> | <u>Sink Current</u> | <u>Output Voltage</u> | |
|------------------|---------------------|-----------------------|-------------|
| | | <i>Low</i> | <i>High</i> |
| -Binning signals | 80 mA max | $\leq 0.5V$ | 5 - 24V |
| -Control signals | 80 mA max | $\leq 0.5V$ | 5 - 24V |

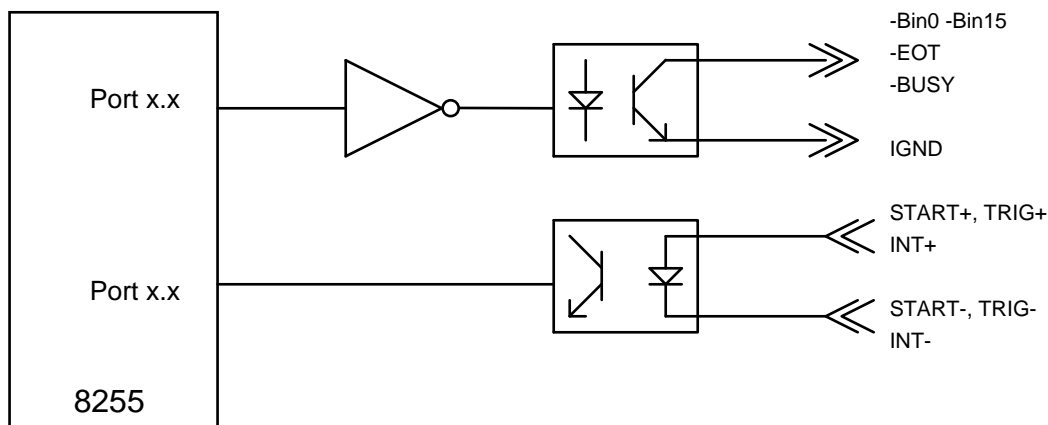

Figure 2-50
I/O Interface Isolation

All handler I/O is conducted through a single 8255. The outputs from the 8255 are optically isolated for added interfacing flexibility and to increase reliability by reducing noise pickup and ground loop interference. The isolators utilize open collector darlington outputs, and can sink up to 80mA of current provided by an external source at up to 24V. No provisions for pull-up resistors are provided on - board. The isolated ground return can be floated, or connected to the 7600 system ground for use with isolated handlers. The isolators are driven by inverting high current buffers. All outputs are asserted active low by writing a logic 1 to the desired bit in the appropriate 8255 port.

All inputs are also optically isolated. Both anode and cathode of the input opto isolators are available in the handler interface connector. Active high inputs can be achieved by grounding the cathode ("-" signal) and driving the anode ("+" signal), while connecting the anode to the external supply and sinking current through the cathode will result in active low drive. No provisions for current limiting resistors are provided on - board. All inputs are reverse bias protected. The isolator outputs are connected directly to the 8255 Port C inputs. Asserting the input to the isolators drives the outputs low; reading a logic 0 from the 8255 input port indicates that the input line has been activated. The START and TRIG isolator outputs are open collector OR'ed to the same 8255 Port C input line; the 7600 cannot tell which of the devices generated the external trigger command.

2.7.2 Parallel Interface

The 7600 comes standard with a parallel printer port available through a connector (25 pin) on the rear panel of the instrument. This is a standard PC compatible interface for connection to a printer. Refer to Table 2-2 for signal names, pin numbers as necessary for cable connections.

**Table 2-2
Parallel Interface Connections**

| Signal Name | Pin Number | Function |
|--------------------|-------------------|--|
| Outputs: | | |
| -STROBE | 1 | Indicates that data is ready to read |
| D0 | 2 | Data bit 1 |
| D1 | 3 | Data bit 2 |
| D2 | 4 | Data bit 3 |
| D3 | 5 | Data bit 4 |
| D4 | 6 | Data bit 5 |
| D5 | 7 | Data bit 6 |
| D6 | 8 | Data bit 7 |
| D7 | 9 | Data bit 8 |
| -AUTOFD | 14 | Auto paper feed |
| -INIT | 16 | Initializes printer |
| -SLCT IN | 17 | Selects printer |
| GROUND | 18 - 25 | Signal ground |
| Inputs: | | |
| -ACK | 10 | Indicates that data has been received and printer is ready to accept more data |
| BUSY | 11 | Indicates that printer can not receive data |
| PE | 12 | Indicates that printer is out of paper |
| SLCT | 13 | Indicates that printer is ready to receive data |
| -ERROR | 15 | Indicates printer error |

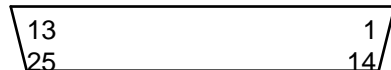

Pin Configuration (Viewed from Rear Panel)

2.7.3 IEEE-488.2 Interface

The 7600 comes standard with IEEE-488 interface with connection through a connector (24 pin) on the rear panel. This interface can be used to connect to a system containing a number of instruments and a controller in which each meets IEEE Standard 488.2 (Standard Digital Interface for Programmable Instrumentation). Refer to Table 2-3 below for a full tabulation of connections and Table 2-4 for the command set.

The following functions have been implemented. Refer to the standard for an explanation of the function subsets, represented by the identifications below.

| | | | |
|-----|--------------------|-----|----------------------|
| SH1 | Source Handshake | PP1 | Parallel Poll |
| AH1 | Acceptor Handshake | DC1 | Device Clear |
| T5 | Talker | DT1 | Device Trigger |
| L3 | Listener | C0 | Controller |
| SR1 | Service Request | E2 | Electrical Interface |
| RL1 | Remote Local | | |

Table 2-3
IEEE-488 Interface Connections

| Signal Name | Pin Number | Function |
|--------------------|-------------------|--|
| DAV | 6 | Low state: "Data is Available" and valid on DI01 through DI08 |
| NRFD | 7 | Low state: At least one listener on the bus is "Not ready for Data". |
| NDAC | 8 | Low state: At least one listener on the bus is "Not Accepting Data". |
| ATN | 11 | "Attention" specifies 1 of 2 uses for the DI01 through DI08 lines Low state - Controller command messages High state - Data bytes from the talker device |
| IFC | 9 | "Interface Clear" Low state - Returns portions of interface system to a known quiescent state. |
| SRQ | 10 | "Service Request" Low state - a talker or listener signals (to the controller) need for attention in the midst of the current sequence of events |
| REN | 17 | "Remote Enable" Low state - enables each device to enter remote mode when addressed to listen High state - all devices revert to local control |
| EOI | 5 | "End of Identify" if ATN is in high state, then low state of EOI indicates end of a multiple-byte data transfer sequence. If ATN is in low state, then low state of EOI activates a parallel poll. |
| DI01 | 1 | The 8-line data bus, which conveys interface messages (ATN low state) or device-dependent messages (ATN high state), such as remote-control commands from the controller or from a talker device |
| DI02 | 2 | |
| DI03 | 3 | |
| DI04 | 4 | |
| DI05 | 13 | |
| DI06 | 14 | |
| DI07 | 15 | |
| DI08 | 16 | |

Table 2-4
IEEE & RS-232 Commands

| Command | Function | Parameter(s) |
|-------------------|--|---|
| CONFigure: | | |
| FREQuency | Set the frequency from 10 to 2000000 Hz | 0000000.00 |
| PPARAmeter | Set the primary parameter | A(auto) CS CP LS LP RP RS DF Q Z Y P(phase angle) ESR GP XS BP |
| SPARAmeter | Set the secondary parameter | N(none) CS CP LS LP RP RS DF Q Z Y P(phase angle) ESR GP XS BP |
| ACTYpe | Set the AC test signal type to This command should be set prior to setting the ACValue. | V I |
| ACVAlue | Set the AC signal to value | 0.0 |
| BIAS | Set the bias to | INT EXT or OFF |
| RANGe | Set the range | AUTO or HOLD or #(1-59) |
| MACCuracy | Set the measurement accuracy | SLOW MEDIUM FAST |
| TDELay | Set the measurement delay | ##### |
| AVERAge | Set # to average | ### |
| MEDian | Set the median function to ON or OFF | ON OFF |
| DISTortion | Set distortion detection to ON or OFF | ON OFF |
| CCHeck | Set the contact check to ON or OFF | ON OFF |
| DISPlay type | Set display type to | M (Measured Parameter) D (Deviation from Nominal) % (% Deviation from Nominal) B (Bin Number) S (Bin Summary) P (Pass/Fail) N (No Display) |
| TRIGger | Set the trigger to | INTernal EXTernal |
| NOMinal | Set the nominal value (for deviation or % deviation) | floating point # |

Table 2-4
IEEE & RS-232 Commands (continued)

| <u>Command</u> | <u>Function</u> | <u>Parameter(s)</u> |
|--------------------------|---|--|
| <u>CONFigure:</u> | | |
| <u>BINNING:</u> | | |
| bin# | | |
| ABS* | Set the low & high limit for the bin | low high (floating point #'s) |
| TOL | Set the % below, % above and nominal value | % below % above nominal (3 floating point #'s w/space between) |
| SECOndary | Set the secondary low & high limit | low high (floating point #'s) |
| TRESet | Reset the bin totals to zero | |
| SUMMery? | Retrieve the bin summary data | |
| FRESult | Set the result format to | SCientific ENGineering |
| HANDler (state) | Turn handler port OFF or ON | ON OFF |
| RPRint | Turn print results ON or OFF | ON OFF |
| RFLoppy: | Results to floppy | |
| DUPLicate | Save results as duplicate filename on floppy | xxxxxxxx |
| NEW | Save results as new filename on floppy | xxxxxxxx |
| APPend | Append results to existing filename | xxxxxxxx |
| CLOSe | Close results of filename | xxxxxxxx |
| <u>SWEep:</u> | | |
| PARAmeter | The parameter to sweep | F (frequency) V (voltage) I (current) |
| BEGin | The beginning value | floating point number |
| END | The ending value | floating point number |
| STEP | The step to increment during the sweep | 10 25 50 100 200 |
| RDISplay | The result display for the sweep | T (table) P (plot) |
| SWEep | Set the sweep function to ON or OFF | ON OFF |
| VALid? | Is filename valid to save to battery backed up RAM? | xxxxxxxx |

* Example CONF: BINN: BIN1: ABS 100 300

**Table 2-4
IEEE & RS-232 Commands (continued)**

| Command | Function | Parameter(s) |
|--------------------------|---|--|
| <u>CONFigure:</u> | | |
| <u>SAVe:</u> | | |
| DUPLicate | Save setup as duplicate filename in battery backed up RAM | XXXXXXXX |
| NEW | Save setup as new filename in battery backed up RAM | XXXXXXXX |
| RECall filename | Recall setup filename from battery backed up RAM | XXXXXXXX |
| FVALid? | Is filename valid to save to floppy? | XXXXXXXX |
| <u>FSAVe:</u> | | |
| DUPLicate | Save setup as duplicate filename on floppy | XXXXXXXX |
| NEW | Save setup as new filename on floppy | XXXXXXXX |
| FRECall filename | Recall setup filename from floppy drive | XXXXXXXX |
| RVALid? | Is results filename valid? | XXXXXXXX |
| <u>SEQuence:</u> | | |
| SEQuence | Set the sequence function to ON or OFF | ON OFF |
| TEST | Enable or Disable a test | test #(1-6) and ENable DISable |
| FREQuency | Set the frequency from 10 to 2000000 HZ | test # and #####.## |
| PPARameter | Set the primary parameter RP LS LP CS CP DF | test # and A(auto) RS Q Z Y P(phase angle) ESR GP XS BP |
| SPARameter | Set the secondary parameter | test # and N(none) RS RP LS LP CS CP DF Q Z Y P(phase angle)ESR GP XS BP |
| ACTYpe | Set the AC test signal type to (This command should be set prior to setting the ACValue) | test # and V I |
| ACValue | Set the AC signal to value | test # and 0.0 |
| BIAS | Set the bias to | test # and INT EXT or OFF |
| RANGe | Set the range | test # and ON OFF |
| TDELay | Set the measurement delay | test # and ##### |
| STOP | Stop on fail | test # and ON OFF |

**Table 2-4
IEEE & RS-232 Commands (continued)**

| Command | Function | Parameter(s) |
|---|---|---|
| <u>LOAD correction:</u> | | |
| NOMinals | Set primary & secondary nominal values | primary secondary (floating point #'s) |
| MEASURE | Perform the Correction Measurement and set Load Correction to On | |
| ON | Set Load Correction to ON (valid only if a Correction Measurement has previously been made) | |
| OFF | Set Load Correction to Off | |
| <u>SYSTEM:</u> | | |
| TIME | Set the time to hours, minutes | hh:mm |
| DATE | Set the date to month, day, year | mm/dd/yyyy |
| LOCKout state | Set the front panel lockout off or on | ON OFF |
| ELAPsed? | Query the elapsed time the machine has run | |
| DCALibration? | Query the calibration date | |
| BLCD | Turn lcd backlite ON or set to screen save | ON SAVE |
| Caution: Setting the remote LOCKout state with certain screens displayed on the unit can prevent one from entering or exiting lockout. | | |
| <u>CALibrate:</u> | | |
| DATA? | Returns the calibration data to the user | |
| QUICKos | Perform quick open calibration | |
| | IEEE wait for SRQ OPC to indicate continue | |
| | Send | Any command if desired to implement |
| | Send | Fetch? This will continue calibration |
| | Receive | Connect the Open Circuit. Ensure that the open is connected to the instrument |
| | Send | CONTINUE |
| | Wait for SRQ OPC (operation complete, IEEE only) | |
| | Perform quick short calibration | |
| | Send | Any command if desired to implement |
| | Send | Fetch? This will continue calibration |
| | Receive | Connect the Short Circuit. Ensure that the short is connected to the instrument |
| | Send | CONTINUE |
| | Receive | Complete (for RS232 only) |
| | Wait for SRQ OPC (operation complete, IEEE only) | |

Table 2-4
IEEE & RS-232 Commands (continued)

| Command | Function | Parameter(s) |
|----------------|---|---------------------|
| SHORT | <p>Perform short circuit calibration</p> <p>The procedure for performing a remote short is as follows:</p> <p>IEEE wait for SRQ OPC to indicate continue</p> <p>Send Any command if desired to implement</p> <p>Send Fetch? This will continue calibration</p> <p>Receive Connect the Short Circuit. Ensure that the short is connected to the instrument</p> <p>Send CONTINUE</p> <p>Receive Complete (for RS232 only)</p> <p>Wait for SRQ OPC (operation complete, IEEE only)</p> | |
| OPEN | <p>Perform open circuit calibration</p> <p>The procedure for performing a remote open is as follows:</p> <p>IEEE wait for SRQ OPC to indicate continue</p> <p>Send Any command if desired to implement</p> <p>Send Fetch? This will continue calibration</p> <p>Receive Connect the Open Circuit. Ensure that the open is connected to the instrument</p> <p>Send CONTINUE</p> <p>Receive Complete (for RS232 only)</p> <p>Wait for SRQ OPC (operation complete, IEEE only)</p> | |
| FULL | <p>Perform full calibration</p> <p>The procedure for performing full calibration is as follows:</p> <p>IEEE wait for SRQ OPC to indicate continue</p> <p>Send Any command if desired to implement</p> <p>Send Fetch? This will continue calibration</p> <p>Receive Connect the 374 Ω Standard. Ensure that the standard is connected to the instrument</p> <p>Send CONTINUE</p> <p>IEEE wait for SRQ OPC to indicate gain cal is done</p> <p>Send Any command if desired to implement</p> <p>Send Fetch? This will continue calibration</p> <p>Receive Connect the open circuit. Ensure that the open is connected to the instrument</p> <p>Send CONTINUE</p> | |

Table 2-4
IEEE & RS-232 Commands (continued)

| <u>Command</u> | <u>Function</u> | <u>Parameter(s)</u> |
|----------------|--|--|
| | IEEE wait for SRQ OPC to indicate open circuit cal is done | |
| | Send | Any command if desired to implement |
| | Send | Fetch? This will continue calibration |
| | Receive | Connect the short circuit. Ensure that the standard is connected to the instrument |
| | Send | CONTINUE |
| | IEEE wait for SRQ OPC to indicate short circuit cal is done | |
| | Send | Any command if desired to implement |
| | Send | Fetch? This will continue calibration |
| | for the next 4 standards | |
| | Receive | Connect the standard. Ensure that the standard is connected to the instrument |
| | Send | CONTINUE |
| | Send | Any command if desired to implement |
| | Send | Fetch? This will continue calibration |
| | Receive | Get prompt for Rnom and Qnom values at 1 kHz |
| | IEEE wait for SRQ OPC to indicate current standard cal is done | |
| | Send | Any command if desired to implement |
| | Send | Fetch? |
| | Receive | Get prompt for Rnom and Qnom values at 1 MHz or 50 kHz |
| | IEEE wait for SRQ OPC to indicate range cal is done | |
| | Send | Any command if desired to implement |
| | Send | Fetch? |
| | after last standard | |
| | IEEE wait for SRQ OPC | |
| | RS232 wait for Complete | |

MEASure

Triggers a measurement of the selected type. If sequence or sweep is enabled this command will trigger those type of measurements also. The result type is set by the display type parameter.

Table 2-4
IEEE & RS-232 Commands (continued)

| Command | Function | Parameter(s) |
|----------------|-----------------|---------------------|
|----------------|-----------------|---------------------|

FETCh?

Fetches the most recent measurement results. The character sequence formats are as follows:

Normal Measurements:

<primary result name> <tab> <primary result> <tab> <units> <secondary result name>
<secondary result> <tab> <units> <tab> <bin or tab> <tab> <#> <tab> <pass string or fail string or tab> <tab> <retest or tab> terminated by a linefeed.

The secondary parameter will be blank when the parameter is set to NONE.

Sweep Measurement:

If sweep is enabled, fetch will give all of the results based on the number of steps selected with the normal measurement format.

FETCh?

Sequence Measurement:

If sequence is enabled, results will be sent for each test enabled.

1st line: <pass/fail bin> <tab> <#> ,

additional lines for tests enabled: <test> <tab> <#> <tab> <primary result> <tab>
<units> <tab> <secondary results> <tab> <units> <tab> <fail or tab> ,

.
.

last line for tests enabled: <test> <tab> <#> <tab> <primary result> <tab> <units> <tab>
<secondary results> <tab> <units> <tab> <fail or tab> terminated by a linefeed.

Bin Summary Measurement:

Bins 1 - 10

<bin> <tab> <#> <tab> <low limit> <tab> <# or tab> <tab> <high limit> <tab> <# or tab> <tab> <total> <tab> <#> terminated by a linefeed.

Bins 11 - 15

<bin> <tab> <#> <tab> <bin description> <tab> <total> <tab> <#> terminated by a linefeed.

Last Line

<totals:> <tab> <pass> <tab> <#> <tab> <fail> <tab> <#> <tab> <#> <tab> <total>
terminated by a linefeed.

Table 2-4
IEEE & RS-232 Commands (continued)

| Command | Function | Parameter(s) |
|--------------------------|--|---|
| <u>LOADFetCh?</u> | Returns load correction status | Valid, measured primary & secondary values or Invalid |
| <u>IDN?</u> | Returns instrument identification | "QuadTech,7600modelb,xx...xx,software version". |
| <u>ESR?</u> | Returns the read of the event status register. | x denotes serial number up to 10 digits |
| <u>STB?</u> | Returns the read of the status byte register. | |
| <u>ESE?</u> | Returns the read of the event status enable register. | |
| <u>SRE?</u> | Returns the read of the service request enable register. | |
| <u>ESE</u> | Set the event status enable register. | value |
| <u>SRE</u> | Set the service request enable register. | value |
| <u>RST</u> | Reset the buffer | |
| <u>TST?</u> | Self test query | |
| <u>CLS</u> | Clear standard event status register | |

Note: Any remote command can start with * symbol for IEEE 488.2 compatibility.

2.7.3.1 Formats

IEEE 488.2 enable remote programming of all instrument functions, measurement conditions and comparator settings etc. Outputs include measurement conditions, open/short corrections, and measured values.

Data Formats

Data will be transmitted in ASCII NR3 format per IEEE488.2 sec. 8.7.4 and reproduced below. Note that there is always precisely one digit before the decimal point, and precisely three digits in the exponent.

Multiple results

For the case where a measurement produces multiple results (e.g. MEASure Cs, and DF), the individual numbers will be separated by commas per IEEE488.2 para. 8.4.2.2.

Sequences of Test (Sequence Mode) will be treated as a single Message Unit, with results separated by commas. If a particular test has “None” selected as a secondary parameter, no place will be reserved for the null result. As an example, a sequence of three tests asking for C/D, ESR, and Z/φ would appear as follows:

<data>,<data>,<data>,<data>,<data><NL>

All response messages will be terminated by the NL character together with the EOI line asserted.

Status Byte Register

| <u>Bit</u> | <u>Decimal Value</u> | <u>Use</u> |
|------------|----------------------|--|
| 7 | 128 | None |
| 6 | 64 | SRQ, SPOL Resets |
| 5 | 32 | Summary of Standard Event Status Register* |
| 4 | 16 | Message Available |
| 3 | 8 | None |
| 2 | 4 | None |
| 1 | 2 | None |
| 0 | 1 | None |

*The Status Byte Register is readable via the standard STB? as defined in para. 11.2.2.2 of the IEEE spec. The 7600 will also implement an SRE register to enable each bit of the Status Byte Register per para 11.3.2 of the IEEE spec. This register shall be readable by a SRE? command and writeable by a SRE <#> command.

Standard Event Status Register

| <u>Bit</u> | <u>Decimal Value</u> | <u>Use</u> |
|------------|----------------------|------------------------------------|
| 7 | 128 | Power Up Since Last Query |
| 6 | 64 | None |
| 5 | 32 | Command Error (Syntax) |
| 4 | 16 | Execution Error (Over Range, etc.) |
| 3 | 8 | No Contact |
| 2 | 4 | Query Error |
| 1 | 2 | None |
| 0 | 1 | Operation Complete |

This register is read by executing an “ESR?” command per para. 11.5.1.2.2 (except no *). Note that this is a destructive read. Reading the register clears it. Each bit of the Event register must be enabled in order to cause the ESB bit of the Status Register to be set. This enabling is done in the Standard Event Status Enable Register by issuing an ESE command per para 11.5.1.3.

2.7.3.2 Sample Program for National Instruments GPIB card

```
260 '*SAMPLE 7600 BASIC PROGRAM FOR NATIONAL INSTRUMENTS IEEE **
' Merge National DECL.BAS here
270 ADAP$="GPIB0" : DEV4$="Dev4": R$ = SPACE$(60)
280 CALL IBFIND (DEV4$,DEV4%)
290 CLS '***** SET CONDITIONS, MEASURE, AND DISPLAY DATA
*****
300 SET$="CONF:REC DEFAULT" : CALL IBWRT (DEV4%,SET$)
310 SET$="CONF:FREQ 1000.00" : CALL IBWRT (DEV4%,SET$)
320 SET$="CONF:PPAR CS" : CALL IBWRT (DEV4%,SET$)
330 SET$="CONF:SPAR DF" : CALL IBWRT (DEV4%,SET$)
340 SET$="CONF:MAC ENH" : CALL IBWRT (DEV4%,SET$)
350 SET$="CONF:NOM 0" : CALL IBWRT (DEV4%,SET$)
360 SET$="CONF:DISP M" : CALL IBWRT (DEV4%,SET$)
370 SET$="MEAS:" : CALL IBWRT (DEV4%,SET$)
380 FOR I = 1 TO 5000 : NEXT I
390 SET$="FETC?" : CALL IBWRT (DEV4%,SET$)
400 CALL IBRD (DEV4%,R$) : PRINT R$
410 CALL IBLOC (DEV4%)
420 END
```

2.7.4 RS232 Interface

The 7600 comes standard with an RS232 serial port interface, available through a connector (9 pin) on the rear panel of the instrument, for connecting to a PC. The RS232 standard defines electrical specifications for the transmission of bit serial information. The use of the RS232 port requires five lines, receive data, transmit data, data terminal ready, data set ready and signal ground. With some controllers additional signals maybe required and are listed in Table 2-5 below. Refer to Figure 2-51 for null modem cable configuration to the standard db9 or db25 connector. Refer to Table 2-4 for the command set which also applies to the RS232 interface.

Table 2-5
RS232 Interface Connections

| Signal Name | Pin Number | Function |
|--------------------|-------------------|---------------------|
| Inputs: | | |
| DCD | 1 | Data Carrier Detect |
| DSR | 6 | Data Set Ready |
| RXD | 2 | Receive Data |
| CTS | 8 | Clear to Send |
| RI | 9 | Ring Indicator |
| Outputs: | | |
| RTS | 7 | Request to Send |
| TXD | 3 | Transmit Data |
| DTR | 4 | Data Terminal Ready |
| GND | 5 | Signal Ground |

| 7600 | | | Controller | |
|-------|---------------------|---------------|------------|---------------------|
| Pin # | Function | | Pin # | Function |
| 2 | Receive data | Connect to | 3 | Transmit data |
| 3 | Transmit data | | 2 | Receive data |
| 4 | Data terminal ready | | 6 | Data set ready |
| 5 | Signal ground | | 5 | Signal ground |
| 6 | Data set ready | | 4 | Data terminal ready |

db9 to db9 Cable Configuration

| 7600 | | | Controller | |
|-------|---------------------|---------------|------------|---------------------|
| Pin # | Function | | Pin # | Function |
| 2 | Receive data | Connect to | 2 | Transmit data |
| 3 | Transmit data | | 3 | Receive data |
| 4 | Data terminal ready | | 6 | Data set ready |
| 5 | Signal ground | | 7 | Signal ground |
| 6 | Data set ready | | 20 | Data terminal ready |

db9 to db25 Cable Configuration

Figure 2-51
RS-232 Cable Configurations

2.7.5 Results to Printer

The 7600 can be setup to output to an RS-232 or IEEE printer. Results format is the same as results to floppy, refer to paragraph 2.6.3.8.

RS-232 RS-232 must be selected on I/O Menu and format set IEEE must also be selected for Talk mode and Disable state.

IEEE IEEE must be selected on I/O Menu and set for Address, Talk mode and Enable state.

2.8 Operation with Accessories

2.8.1 General

A wide selection of accessories such as test leads, cables and fixtures are available from QuadTech to enhance the operation of the 7600 Precision LCR Meter. A full list of accessories is given in paragraph 1.5 of this instruction manual and each is discussed in more detail below. Some accessories may include information and or installation instructions that are not repeated here.

NOTE:

Instrument accuracy can be reduced from nominal specifications when using some 7000 accessory fixtures and cables. Best accuracy requires geometric consistency between that utilized during open/short zeroing and that utilized on fixtures and cables during the actual measurement process. This consistency may be especially difficult to achieve when using unshielded Kelvin clip and tweezer type connections.

2.8.2 Rack Mount Kit (7000-00)

The 7000-00 Rack Mount Kit is used to install the 7600 in a rack mount configuration. The main components of the kit include front handles, front angle brackets, rear vertical trim pieces and rear support brackets. Assembly instructions (QuadTech Form # 150077) are provided with the kit.

2.8.3 BNC Cable Set, 1 Meter (7000-01), 2 Meter (7000-02)

The 7000-01 and 7000-02 are BNC to BNC cable sets used for connecting fixtures, component handlers or other measurement devices to the measurement terminals of the 7600. The only difference between the two is that the 7000-01 cable is 1 meter in length and the 7000-02 is 2 meters in length.

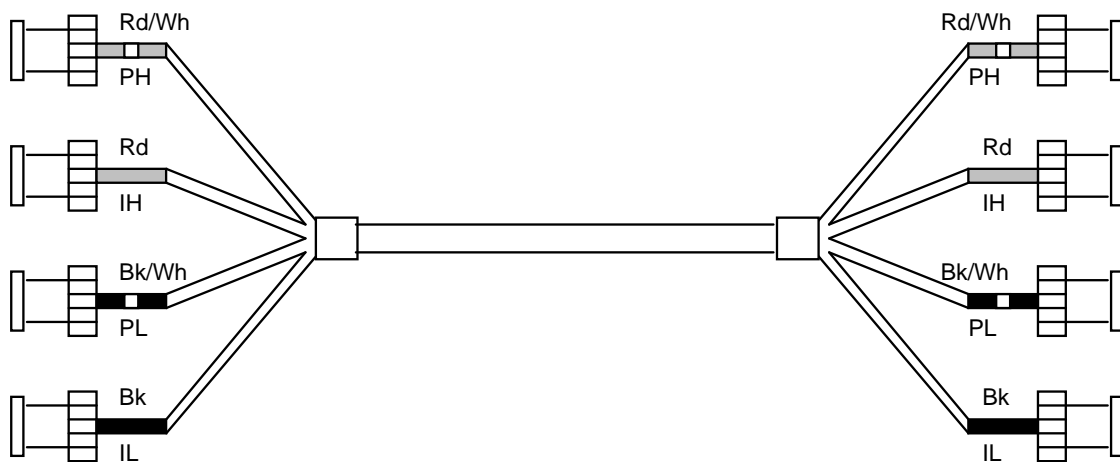

Figure 2-52: BNC Cable Sets

Connection to 7600:

| <u>Connect to 7600</u> | <u>Cable Marking/Color</u> | <u>Connection to DUT</u> |
|------------------------|----------------------------|------------------------------|
| PH (potential, high) | PH (Red/white) | Positive (+) terminal of DUT |
| IH (current, high) | IH (Red) | Positive (+) terminal of DUT |
| PL (potential, low) | PL (Black/white) | Negative (-) terminal of DUT |
| IL (current, low) | IL (Black) | Negative (-) terminal of DUT |

Note: H and L denote polarity of AC test signal at 7600 measurement terminals as well as the + and - polarity of DC bias voltage when applied.

2.8.4 Kelvin Clip Leads (7000-03)

The 7000-03 Kelvin Clip Leads provide a means for easily making four-terminal connections to passive components when they are tested by the 7600. This cable is especially useful for testing low-impedance devices that have large or non-standard terminations, devices such as electrolytic capacitors and inductors.

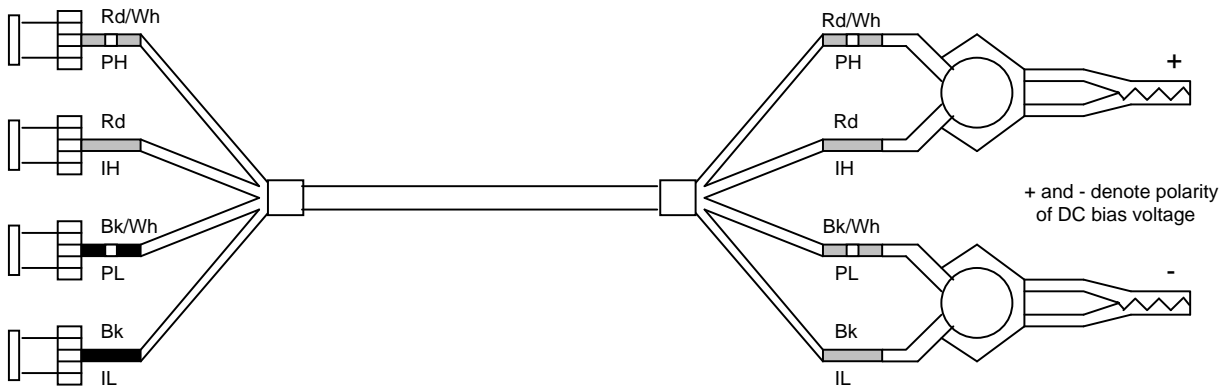

Figure 2-53
Kelvin Clip Leads

For this accessory an additional accuracy (for parameters listed) must be added to the standard instrument accuracy as defined by AutoAcc.

C: +/- 1.5 pF R: +/- 10 mohms L: +/- 100 nH
 Q: for R > 100 ohms, +/- 9 * Freq * R * 10⁻¹² ppm
 for R < 100 ohms, +/- (R/Freq) * 10⁻⁶ ppm

Measurement accuracy is very sensitive to connection geometry. The same connection geometry must be used for open/short compensation as for connection to the device under test.

Connection to 7600:

Connection to the 7600 is made through four shielded cables with BNC connectors that mate directly with the measurement terminals of the 7600. The cables are color coded to facilitate proper connections as detailed below.

| <u>Connect to 7600</u> | <u>Cable Marking/Color</u> | <u>Connection to DUT</u> |
|------------------------|----------------------------|------------------------------|
| PH (potential, high) | PH (Red/white) | Positive (+) terminal of DUT |
| IH (current, high) | IH (Red) | Positive (+) terminal of DUT |
| PL (potential, low) | PL (Black/white) | Negative (-) terminal of DUT |
| IL (current, low) | IL (Black) | Negative (-) terminal of DUT |

NOTE:

H and L denote polarity of AC test signal at 7600 measurement terminals as well as the + and - polarity of DC bias voltage when applied

Open/Short Zeroing:

When these Kelvin Test Leads are used an open/short-circuit "zeroing" procedure should be done, as described in paragraph 2.4 of this manual, to correct for residual resistance and inductance. The following diagram shows how to connect the clips for the short-circuit "zero."

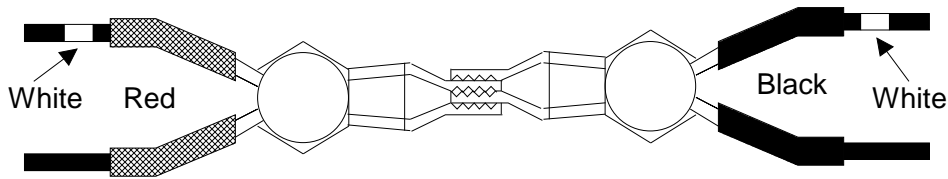

Figure 2-54
Kelvin Test Leads Open/Short Zeroing

2.8.5 Alligator Clip Leads (7000-04)

The 7000-04 Alligator Clip Leads is generally used to connect to devices that are multi-terminal, physically large or otherwise unsuited for one of the remote test fixtures. The lead set consists of a BNC to BNC cable, four banana plug adapters and four alligator clips. One of the banana plug adapters is supplied with a pigtail for connecting a "guard" if necessary.

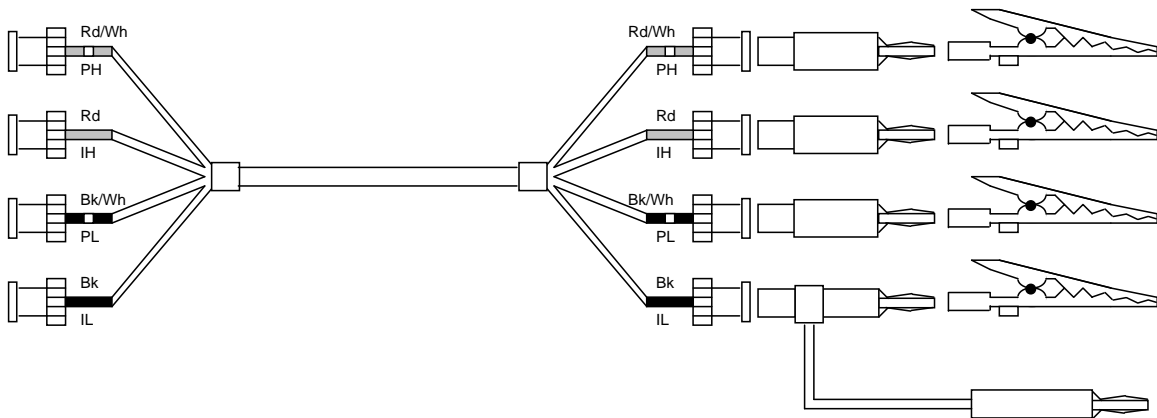

Figure 2-55
Alligator Clip Leads

For this accessory an additional accuracy (for parameters listed) must be added to the standard instrument accuracy as defined by AutoAcc.

C: +/- 1.0 pF R: +/- (10 mohms + R/5 * 10⁶)
 Q: +/- 50 ppm
 for R > 100 ohms, +/- 4 * Freq * R * 10⁻¹³ ppm

Measurement accuracy is very sensitive to connection geometry. The same connection geometry must be used for open/short compensation as for connection to the device under test.

Connection to 7600:

| <u>Connect to 7600</u> | <u>Cable Marking/Color</u> | <u>Connection to DUT</u> |
|------------------------|----------------------------|------------------------------|
| PH (potential, high) | PH (Red/white) | Positive (+) terminal of DUT |
| IH (current, high) | IH (Red) | Positive (+) terminal of DUT |
| PL (potential, low) | PL (Black/white) | Negative (-) terminal of DUT |
| IL (current, low) | IL (Black) | Negative (-) terminal of DUT |
| | | Guard of DUT |

NOTE:

H and L denote polarity of AC test signal at 7600 measurement terminals as well as the + and - polarity of DC bias voltage when applied

2.8.6 Chip Component Tweezers (7000-05)

The 7000-05 Chip Component Tweezers provides a means for handling small unleaded "chip" or SMD (surface mounted devices) passive components for testing on the 7600. They are intended for both handling small components and the means for making electrical test connection to them. A four-terminal Kelvin connection extends to the tip of the tweezers where the measurement becomes two-terminal, therefore series impedance of the connecting cables and internal tweezer connections do not affect the measurement. The small amounts of residual-tip resistance and inductance can be automatically corrected by using the 7600 shorting function with the tips pressed together. Guard shields between the tweezer blades minimize capacitance between them. A correction for this small capacitance can be made using the 7600 open circuit test with the tips held at a spacing equal to that of the component's contact spacing.

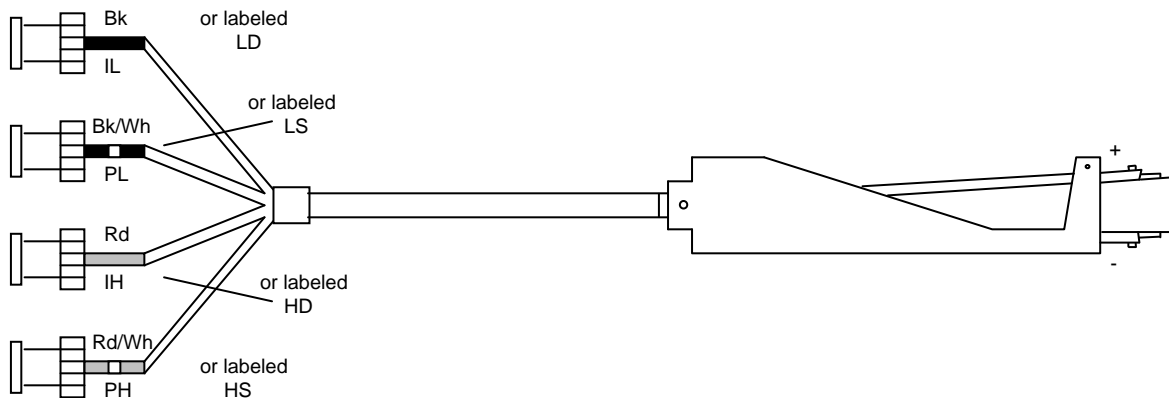

Figure 4-56
Chip Component Tweezers

For this accessory an additional accuracy (for parameters listed) must be added to the standard instrument accuracy as defined by AutoAcc.

C: +/- 1.5 pF R: +/- 10 mohms L: +/- 100 nH
Q: for R > 100 ohms, +/- 9 * Freq * R * 10⁻¹² ppm
for R < 100 ohms, +/- (R/Freq) * 10⁻⁶ ppm

Measurement accuracy is very sensitive to connection geometry. The same connection geometry must be used for open/short compensation as for connection to the device under test.

Connection to 7600:

| <u>Connect to 7600</u> | <u>Cable Marking</u> | <u>Connection to DUT</u> |
|------------------------|----------------------|-----------------------------------|
| PH (potential, high) | PH (Rd/Wh) or HS | + to positive (+) terminal of DUT |
| IH (current, high) | IH (Rd) or HD+ | + to positive (+) terminal of DUT |
| PL (potential, low) | PL (Bk/Wh) or LS | - to negative (-) terminal of DUT |
| IL (current, low) | IL (Bk) or LD | - to negative (-) terminal of DUT |

The PH (HS) and IH (HD) cables connect to the fixed arm of the tweezers (+) and the PL (LS) and IL (LD) cables connect to the movable arm of the tweezers (-). To ensure valid measurements it is especially important to observe the correct polarity when DC bias is to be used.

2.8.7 Low V, Axial/Radial Lead Component Test Fixture (7000-06)

The 7000-06 Test Fixture, along with the BNC to BNC cable provided, is a method of convenient, reliable, guarded 4-terminal connection of radial and axial leaded components to the 7600. The 7000-06 consists of the test fixture and two axial lead adapters.

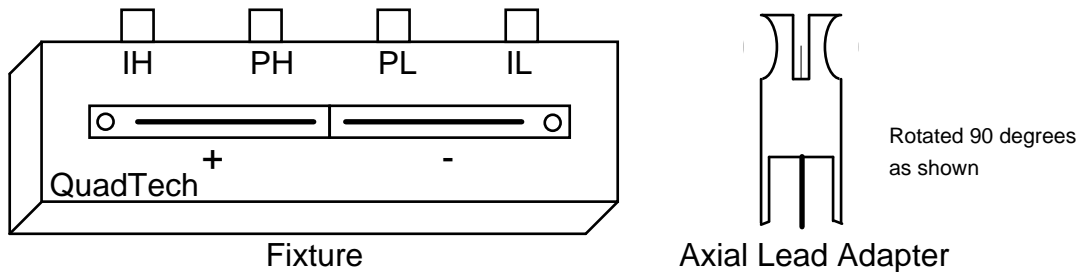

Figure 2-57
Low V, Axial/Radial Lead Component Test Fixture

For this accessory an additional accuracy must be added to the standard instrument accuracy as defined by AutoAcc.

For 1 MHz Special Case Accuracy

Primary readings: +/- 0.06%

Secondary readings: +/- 600 ppm

Connection to 7600 (using 7000-01 or 7000-02 BNC Cable Sets):

| <u>Connect to 7600</u> | <u>Cable Marking/Color</u> | <u>Connect to Test Fixture</u> |
|------------------------|----------------------------|--------------------------------|
| PH (potential, high) | PH (Red/white) | PH |
| IH (current, high) | IH (Red) | I H |
| PL (potential, low) | PL (Black/white) | PL |
| IL (current, low) | IL (Black) | IL |

If the device under test (DUT) is a radial lead component it can be inserted directly into the fixture slots. The slots accommodate wires with diameters from 0.25 mm to 1 mm (AWG 30 to AWG 18 wire). If the DUT is an axial-lead component the two axial lead adapters should be installed in the fixture (by pushing vertically downward) and the component installed in them. These adapters accommodate wire with diameters up to 1.5 mm (AWG 15 wire). When removing, lift with a gentle tilt left or right, **never forward or back**.

Open/Short Zeroing:

Instrument zeroing should be performed once the test fixture is connected. For information refer to paragraph 2.2 on Instrument Zeroing. For an open, a lead should be inserted in the + slot and another lead in the - slot to ensure good contact between the wiper blades, and for a short the + and - contacts should be shorted together with bus wire, the larger the better, but in accordance with wire sizes discussed above. It should be noted that if measurements are to be made on the very lowest range (20 mohm full scale), readings could be in error, although small, by the resistance value of the short itself. The approximate value of the shorting wire can be determined by zeroing the instrument using the standard 4-terminal Kelvin clips and then measuring the resistance of the shorting wire.

2.8.8 Low V, Chip Component Test Fixture (7000-07)

The 7000-07 Test Fixture, along with the BNC to BNC cable provided, is a method of convenient, reliable, guarded 4-terminal connection of chip or surface mount components.

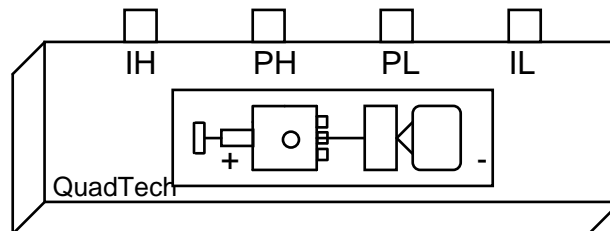

Figure 2-58
Low V Chip Component Test Fixture

Maximum Frequency:

2 MHz

Typical Residual Parameters (after performing open/short at DUT terminals):

C: $< 0.15 (1 + 0.002/f)$ pF L: $< 10 (1 + 0.002/f)$ nH R: $< 1 (1 + f^2)$ m Ω

where f = measurement frequency in MHz

Connection to 7600 (using 7000-01 or 7000-02 BNC Cable Sets):

| <u>Connect to 7600</u> | <u>Cable Marking/Color</u> | <u>Connect to Test Fixture</u> |
|------------------------|----------------------------|--------------------------------|
| PH (potential, high) | PH (Red/white) | PH |
| IH (current, high) | IH (Red) | I H |
| PL (potential, low) | PL (Black/white) | PL |
| IL (current, low) | IL (Black) | IL |

Open/Short Zeroing:

Instrument zeroing should be performed once the test fixture is connected. Refer to the instrument zeroing instructions for further information. For an OPEN the DUT should be removed but the fixture spacing should be the same as the device. This can be done by tightening the screw that holds the contact, as shown below. For a SHORT the fixture contacts should be shorted together with a shorting block equivalent to spacing of the device under test.

Use of this fixture may result in an incremental error due to residuals at DUT terminals. Verify with a known standard and apply this offset to final measurements.

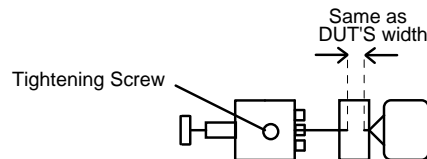

2.8.9 High Voltage Test Fixture (7000-08)

The 7000-08 Component Test Fixture, along with BNC to BNC cable provided, is an accessory for QuadTech's 7600. The fixture simplifies the connection and measurement of leaded and chip components while maximizing operator ease of use and safety. The fixture is supplied with plug-in modules for leaded and surface mount components, plus banana-plug cables and alligator clips for connecting a wide variety of other component styles. The unit is designed with a shielded case to reduce potential measurement errors due to electrical noise and a hinged cover, with a safety interlock switch, is included for operator safety. A start button, test active indicator is located on the fixture for operator convenience and ease of use.

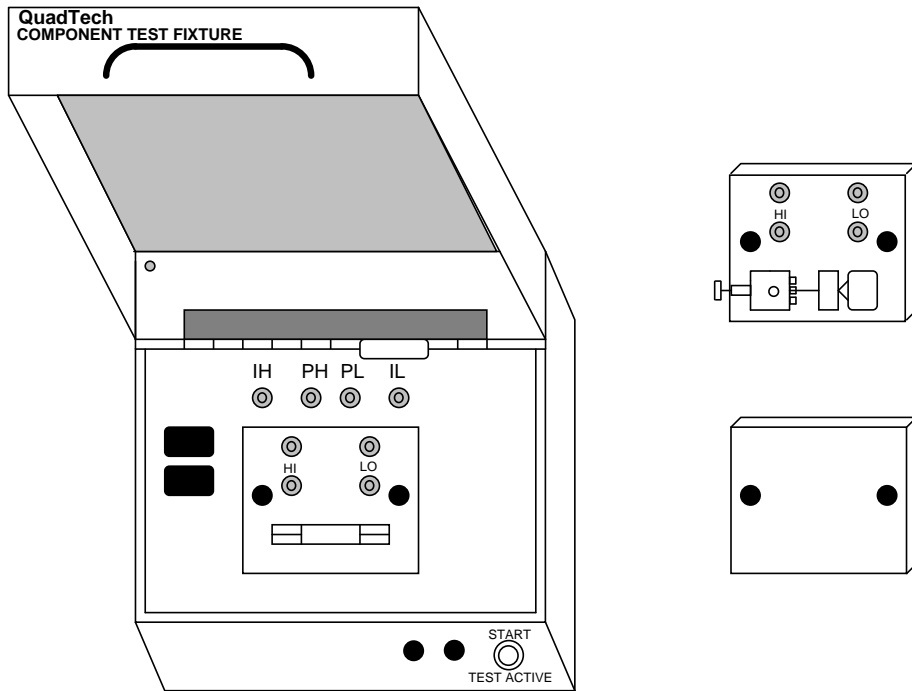

Figure 2-59
High Voltage Test Fixture

2.8.10 Calibration Kit (7000-09)

The 7000-09 Calibration kit consists of four calibration resistors, an open-circuit module and a short-circuit module. These standards are NIST traceable and used to re calibrate the 7600 Precision LCR Meter. The four calibration resistors have nominal values of 24.9, 374 ohms; 5.97 and 95.3 kohms. R and Q values are given for all four resistors at 1 kHz, R and Q values are also given at 25 kHz for the 95.3 kohm resistor, 250 kHz for the 5.97 kohm resistor and both 500 kHz and 1 MHz for the other two resistors. 500 kHz for calibration of 7400's and 1 MHz for calibration of 7600's. Refer to Calibration Procedure, paragraph 4.4 of this manual for more detail.

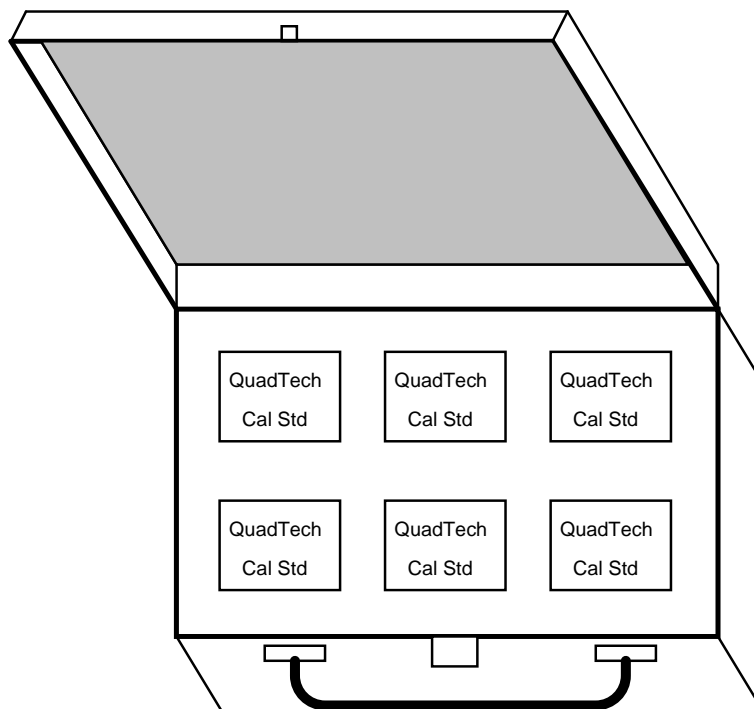

Figure 2-60
Calibration Kit

2.8.11 Connection to "Type 874" Connectors

There are times when it may be desirable to connect the 7600 to type 874 coaxial connectors that are found on some impedance standards. This connection can be made using either the 7000-01 or 7000-02 BNC to BNC Cable, two BNC Tees and two BNC to 874 adapters (see below).

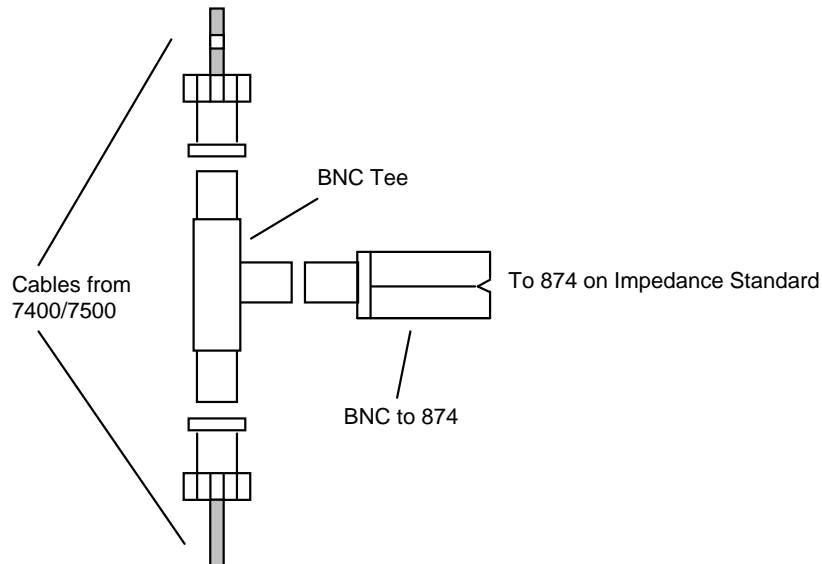

Figure 2-61
Connection to 874 Connectors

Sources for BNC to 874 Adapters:

Gilbert Engineering
P.O. Box 23189
Phoenix, AZ 85063
602-245-1050

Delta Electronics
416 Cabot Street
Beverly, MA 01915
508-927-1060

Pasternack Enterprises
P.O. Box 16759
Irvine, CA 92713
714-261-1920

2.9 Error Messages

| | |
|--|--|
| "AC CURRENT ERROR, SET TO 250 μ A" | AC current level improperly set |
| "AC VOLTAGE ERROR, SET TO 1V" | AC voltage level improperly set |
| "BAD CALIBRATION CODE ENTERED" | Calibration code incorrectly entered |
| "BAD CALIBRATION DATA" | Calibration incorrect, re calibrate |
| "BAD DRIVE-REQUEST STRUCTURE" | Floppy not present, defective or disk not inserted |
| "BAD OPEN CALIBRATION DATA" | Repeat Open test |
| "BAD SETUP DATA READ FROM MEMORY" | Setup data incorrect, reload |
| "BAD SHORT CALIBRATION DATA" | Repeat Short test |
| "BIN CHECKSUM ERROR, TOTALS SET TO 0" | Bin count incorrect |
| "CRC ERROR ON FLOPPY" | Stored setup lost or corrupt (cyclic-redundancy-check) |
| "CURRENT MODE, BIAS SET TO OFF" | |
| "DISK WRITE PROTECT ERROR" | Floppy disk is write protected |
| "ELAPSED TIME ERROR, SET TO 0" | Elapsed time is incorrect and has been set to zero (battery for non-volatile memory may be defective or has been disconnected) |
| "ERROR DURING CALIBRATION" | Calibration incorrect, re calibrate |
| "ERROR DURING OPEN CALIBRATION" | Repeat Open test |
| "ERROR DURING SHORT CALIBRATION" | Repeat Short test |
| "FAILURE # SEE DOCUMENTATION" | Hardware or software failure, 1 - 99 (# list not included in this manual) |
| "FILE ACCESS VIOLATION" | File selected from floppy is Read Only |

| | |
|-------------------------------------|---|
| "FILE DOES NOT EXIST" | File name incorrect |
| "FILE EXISTS" | File already exists under the chosen name |
| "FLOPPY DRIVE NOT READY" | Floppy not present, defective or disk not inserted |
| "FLOPPY MEDIA DEFECT" | Disk defective, format or replace |
| "FLOPPY READ FAULT" | Floppy not present, defective or disk not inserted |
| "FLOPPY SAVE ERROR" | Setup not properly saved |
| "FLOPPY SECTOR UNFORMATTED" | Floppy disk is not formatted |
| "FLOPPY SEEK ERROR" | Floppy not present, defective or disk not inserted |
| "FLOPPY WRITE FAULT" | Floppy not present, defective or disk not inserted |
| "GENERAL FAILURE, FLOPPY" | Floppy not present, defective or disk not inserted |
| "HANDLER PORT FAILURE" | I/O port malfunction during power up |
| "HARDWARE TIMER FAILURE, REBOOT" | Hardware malfunction during power up |
| "HIGH LIMIT LESS THAN LOW LIMIT" | Limits incorrectly set |
| "INTERNAL HARDWARE FAILURE, REBOOT" | Hardware malfunction during power up |
| "INVALID FREQUENCY SELECTED" | Select a valid frequency |
| "INVALID RANGE SELECTED" | Select another range |
| "LOW BATTERY VOLTAGE" | Memory backup battery, low voltage (setups and instrument zero could be lost) |
| "MAXIMUM # OF SETUPS REACHED" | Maximum number of files have been stored |
| "NO IEEE 488 INTERFACE" | Unit does not include IEEE-488 |

| | |
|--|--|
| "NO INTERLOCK SIGNAL" | Open interlock connection at rear panel I/O Port |
| "NO PASSWORD ENTERED" | Password entry canceled, re-enter |
| "NO ZERO DATA FOUND" | Unit requires zeroing |
| "PASSWORD DID NOT MATCH" | Incorrect password entered |
| "PASSWORD NOT SAVED IN RAM" | Error trying to save password, repeat |
| "PASSWORD VERIFICATION FAILURE" | Wrong password entry for verification |
| "PRI & SEC MISMATCH, SET TO AUTO" | Check parameter selection |
| "PRIMARY = AUTO, CAN'T UPDATE AUTOACC" | Check parameter selection |
| "PRIMARY = AUTO, SECONDARY IGNORED" | Check parameter selection |
| "PRINTER ERROR, CHECK PRINTER" | Printer error |
| "PRINTER OUT OF PAPER" | Printer out of paper |
| "QUICK OPEN / SHORT INVALID, RE-ZERO" | |
| "REMOTE COMMAND INVALID" | IEEE or RS232 command is incorrect (for example: to set frequency use FREQuency) |
| "REMOTE COMMAND PARAMETER INVALID" | IEEE or RS232 parameter is incorrect (for example: frequency parameter can be XXXXXXXX.XX) |
| "REMOTE COMMAND PREFIX INVALID" | IEEE or RS232 command prefix is incorrect (for example: to configure unit use CONFigure) |
| "SHUT THE POWER OFF" | Malfunction of instrument power source |
| "SWEEP BEGIN & END ARE EQUAL" | Sweep range improperly set |
| "SWEEP BEGIN / END VALUES TOO CLOSE" | Sweep range improperly set |

| | |
|--------------------------------------|---|
| "SWEEP BEGIN VALUE GREATER THAN END" | Sweep range improperly set |
| "TIME / DATE ERROR, PLEASE SET" | Reset time and date |
| "TOO MANY KEYS, LAST KEY IGNORED" | Too many keys for entry field |
| "UNABLE TO READ FROM FLOPPY" | Floppy not present, defective or disk not inserted |
| "UNABLE TO READ THAT FILENAME" | Selected file unreadable, improper format |
| "UNABLE TO WRITE TO REMOTE" | IEEE or RS232 not setup correctly or IEEE not present |
| "UNKNOWN COMMAND" | |
| "UNKNOWN UNIT" | Floppy drive is not recognized (not present or defective) |
| "VALID RANGE = low value - hi value" | Entry invalid, should be between specified values |
| "WARNING $V > 1$, BIAS NOT AT 2V" | DC bias voltage incorrect |

3.1 General

The 7600 Precision LCR Meter is built on QuadTech's I2000 standard instrument architecture that consists of a standard mechanical package, LCD display/keypad, microprocessor unit, digital I/O interface and power supply. The I2000 further incorporates the circuitry unique to the 7600, an analog instrument module and power supply. In addition there are two basic I2000 options, the IEEE-488 card and floppy drive/controller card. Each of these modules is discussed briefly below.

3.2 Instrument Description

3.2.1 Basic I2000 Instrument Architecture

Processor Board

The processor board provides the basic control for the 7600 and mimics the IBM-PC architecture. Besides the central processing unit and memory modules it includes DOS, keypad and RS232 ports. The RS232 port is connected to its rear panel connector by a cable. The processor board is stacked on the Digital I/O Board that is mounted on the Analog Instrument board. The processor board can have the IEEE-488 and/or floppy drive controller option boards stacked on it if either or both options are present.

Power Supply

The power supply assembly consists of two modules, a +5V, -12V and +24V module towards the back of the instrument and a +/-12V module towards the front. The +5V supplies power to most of the instrument's basic boards/modules, including the processor board, digital I/O board, LCD display, IEEE-488 board, floppy drive and floppy drive controller board. It also provides power for the digital logic on the analog instrument board. The +24V of this module supplies the instrument fan and the -12V is not used. The +/- 12V module supplies most of the power to the analog instrument board.

Digital I/O Board

The digital I/O board provides interface to the LCD display, the keypad and provides handler interface functions through a cable to the rear panel connection. It also contains the circuitry for the instrument's many timing functions as well as a non-volatile memory used for storing test setup conditions and corrections for instrument zeroing. The battery backup for the RAM on this board consists of 3-AA alkaline batteries. The batteries should be changed once a year. This board is mounted on the analog instrument board in the instruments main compartment. The 3 batteries are installed in the long round tube towards the rear left of the unit.

LCD Display/Keypad Panel

The front panel user interface is comprised of a molded silicon rubber keypad that actuates a membrane switch assembly. The keypad is environmentally sealed, designed for long life and all keys with tactile feedback to the operator. The 2 1/2" x 4 3/4" LCD is a high resolution graphic display with on/off back light for visual clarity. Both keypad and display are connected to the instrument I/O board via ribbon cables.

3.2.2 7600 Instrument Module

The 750068 instrument board, used in the Model 7600 Precision LCR Meter, is the heart of the measurement system. All other boards support its operation. There are five major parts to this board: sine wave generator, voltage detector channel, current detector channel, A/D converter, and Digital Signal Processor. Each is discussed below in brief.

Sine Wave Generator

All devices under test are tested by applying a sine wave of voltage or current. The sine wave is generated by use of an IC using the Direct Digital Synthesis technique. This allows generation of all frequencies from 10 Hz to 2 MHz with a high level of resolution.

Voltage Detector Channel

The sine wave test signal is applied to the unknown through the IH and IL leads, causing a voltage to appear across the unknown. This voltage, E_x , is measured by the PH and PL leads, is filtered and amplified according to its level, and presented to one channel of the Dual A/D converter.

Current Detector Channel

The current flowing through the unknown is applied to a transadmittance amplifier with an internal standard in the feedback path. This arrangement causes a voltage to be generated across the standard resistor proportional to the current. This voltage is also filtered and amplified and presented to the second channel of the A/D converter.

A/D Converter

The two signals representing 'voltage across' and 'current through' the unknown are digitized by a dual 18 bit A/D converter. A key concept of this conversion is that the samples are taken synchronously with the digital generation of the sine wave so that phase information may be obtained.

Digital Signal Processor

The digitized voltage and current signals are applied to a high speed Digital Signal Processor where a mathematical algorithm (similar to a Fast Fourier Transform) is used to extract the in phase and quadrature portions of the signal. This information is then used to calculate the complex impedance, Z , and the complex admittance, Y of the unknown. These results are then used to compute the parameters requested by the user i.e. C, R, L, D, Q etc.

3.2.3 I2000 Instrument Options

IEEE-488 Board & Cable

The IEEE-488 board (unless deleted as an option) allows complete control over all aspects of the instrument. Any user control available through the keyboard or any information available for display can be accessed over this interface. This board is mounted towards the right rear of the unit stacked above the processor board and above or below the floppy drive controller board (order of these two is not important but dependent on which option was installed last). Connection to the IEEE-488 connector on the rear panel is via an interconnecting cable.

Floppy Drive

The 3.5" floppy drive (unless deleted as an option) is used for storing multiple setup conditions beyond what can be retained in the internal RAM of the unit and for storing test results. The drive will handle standard 3.5" floppies, offering 1.44Mbits of memory in DOS compatible file format, thus the setup conditions and results are readable on an IBM-PC or equivalent.

Floppy Drive Controller Board

A floppy drive controller card (unless deleted as an option) provides the interface between the instrument processor and the 3.5" drive unit. This is mounted towards the right rear of the unit stacked above the processor board and above or below the IEEE-488 board (order of these two is not important). Connection to the drive unit itself is via an interconnecting cable.

Section 4

Maintenance & Calibration

4.1 General

Our warranty (at the front of this manual) attests to the quality of materials and workmanship in our products. If malfunction should be suspected or other information be desired, applications engineers are available for technical assistance. Application assistance is available in the U.S. by calling 800-253-1230 and asking for Applications Support. For support outside of the United States, please contact your local [QuadTech Distributor](#).

4.2 Instrument Return

Before returning an instrument to QuadTech for [Service](#) please obtain an [online Return Materials Authorization Number \(RMA#\)](#). This number, when placed on the outside of the shipping package, will speed processing at our Service Lab and will serve as a reference number for the time your unit is at QuadTech. Please contact our **Customer Care Center (CCC)** at **800-253-1230** for additional support. The CCC phone line is staffed from 8:00am to 5:00pm (EST).

It will be necessary to include a Purchase Order Number and credit card information to insure expedient processing, although units found to be in warranty will be repaired at no-charge. For any questions on repair costs or shipment instructions please contact our CCC Department at the above number. To safeguard an instrument during storage and shipping please use packaging that is adequate to protect it from damage, i.e., equivalent to the original packaging and mark the box "Delicate Electronic Instrument". Please follow online instructions for shipping materials back to QuadTech.

4.3 Routine Maintenance

4.3.1 Battery Replacement

Backup power for the instruments non-volatile memory is supplied by 3 standard AA batteries. These should be **replaced annually with alkaline batteries**, otherwise damage to the unit is possible as a result of battery leakage. QuadTech will assume no responsibility for instrument damage resulting from the batteries not being changed as recommended. To replace the batteries proceed as follows:

1. Instrument power needs to be on but not in the measurement mode.

CAUTION

If the batteries are removed with the power off there would be no power to the non-volatile memory and important data such as stored test conditions would be lost.

2. Place a flat head screwdriver in the groove of the battery compartment end cap and rotate counterclockwise (ccw) about 1/4 turn to remove.
3. Lift the front of the instrument up slightly so that the batteries slide out of the compartment.
4. Install three new batteries, **positive side out**.

CAUTION

Do not install the batteries backwards

5. Reinstall the end cap and rotate clockwise (cw) to secure.

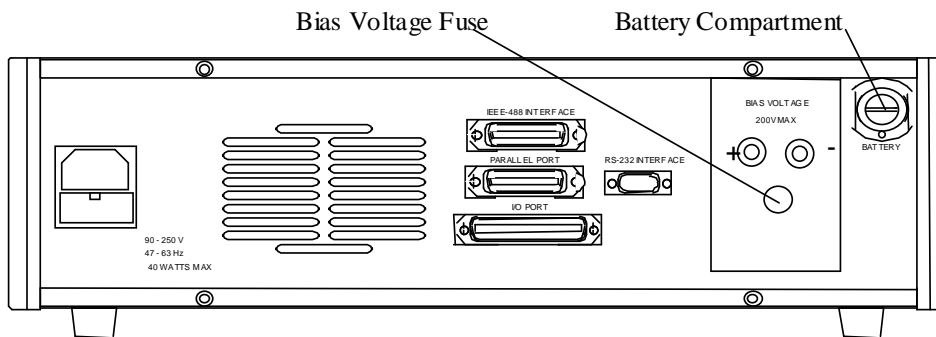

Figure 5-1
Battery Compartment

4.3.2 Bias Voltage Fuse Replacement



The bias voltage fuse is type F0.25A, 250V, 5x20mm fast blow. Replace only with the same rated fuse. **Make sure the instrument is off and disconnected from its ac power source.** The fuse holder can be removed by rotating ccw with a flat head screwdriver.

4.3.3 Resetting of Time and Date

If for some reason the backup power supplied by the 3 AA batteries should fail during shipment of the instrument (due to shock, vibration or extreme temperature) the unit will lose its zero, time and date, elapsed time and stored setup conditions. An indication of such an occurrence would be the display of the error message "ELAPSED TIME"

ERROR, SET TO 0" when the unit is first powered up. The most likely cause would be an intermittent connection to the battery due to shock or vibration. **It is very important that the time and date be reset and the instrument zeroed before proceeding with any measurements.** Proceed as follows:

1. Press **MENU** key to select menu display.
2. Press **Right or Left Arrow** key to select Utilities menu.
3. Press **Up or Down Arrow** key to select Set Time/Date.
4. Press **ENTER** key to activate the entry field.
5. Set the current time and date as instructed on the display, refer to paragraph 2.6.5.7 if necessary. After the time and date have been reset press **MENU** to return to the menu display.
6. Press **Up or Down Arrow** key to select Zero.
7. Press **ENTER** key to activate the Zero routine and follow instructions on the instrument display.
8. Once the Time and Date have been reset and the instrument zeroed the 7600 is ready for routine measurements. It's important to note that the elapsed time will have been reset back to zero during this process.

4.3.4 Loss of Display Contrast

If for some reason the instrument should loose its display contrast, it is possible to reset it easily using the procedure below. Loss of contrast would exhibit no display at all when the instrument is powered up.

Procedure for restoring loss of contrast:

1. Consider the SELECT buttons as labeled 1, 2, 3, and 4 from top to bottom.
2. Turn the instrument on and wait 10 seconds.
3. Press MENU key twice.
4. Press SELECT "4" one time.
5. Press SELECT "1" three times.
6. Press ENTER.
7. Press SELECT "1" many times till contrast returns to normal.
8. Press ENTER.
9. Arrow up to SAVE SETUP and save as DEFAULT.

If the above procedure fails to restore the contrast try repeating again. Failing restoration of the contrast may be indication of another instrument problem.

4.3.5 Preventive Maintenance/Cleaning

In addition to the annual battery replacement and calibration discussed below periodic cleaning of dust from the 3 1/3" disk drive is recommended depending on the environmental conditions. Vacuuming of the drive by qualified service personnel should be done in accordance with common procedures used in computer maintenance.

4.4 Calibration

4.4.1 General

Calibration of the 7600 Precision LCR Meter is recommended on an annual basis. If the unit is to be returned to QuadTech for factory calibration refer to paragraph 4.2 for instructions. **Using the procedure below the instrument can also be calibrated by a qualified service person if traceable calibration equipment and standards are available.**

CAUTION

Instrument should be powered up for a minimum of 1 hour before calibration to ensure maximum stability.

Requirements for Re calibration

Temperature stabilized room at 23 degrees C (73.4 F)
QuadTech 7000-09 Calibration Kit

4.4.2 Calibration Procedure

Select CALIBRATION on the Utilities menu. Once ENTER is selected the calibration code of 7600225 must be entered to continue. This code is to prevent unauthorized personnel from effecting the instrument calibration. For security reasons it may be desirable to blank out the code (above) in this instruction manual.

The step by step instructions for this procedure is shown on the instrument display.